

ROKON®



OWNER'S MANUAL

INCLUDES ILLUSTRATED PARTS GUIDE

Copyright 2021 Rokon International Inc. Printed in the U.S.A. ROKON and its logo are registered trademarks.

Rev 8.2



ROKON OWNER'S MANUAL

COVERS ALL SCOUT, TRAIL-BREAKER AND RANGER MODELS 2016 AND NEWER

ROKON International

50 Railroad Ave

Rochester, NH 03839

TEL: (603) 335-3200

www.rokon.com

INTRODUCTION

Thank you for choosing ROKON. Welcome to the fun and exciting world of 2x2 all-terrain motorcycles! For over 60 years ROKON has been producing the world's most capable off road vehicle. Now it's your turn to feel the adventure and independence that can exclusively be found on the only "true" all-terrain vehicle on planet Earth! This manual will familiarize you with operation of your new ROKON. It also contains periodic maintenance procedures and a comprehensive troubleshooting guide. Enclosed you will also find important safety information, warranty information and a detailed parts guide that can be used to identify and order replacement components.

Congratulations on your purchase! By studying this manual and following the procedures outlined within you will be rewarded with years of reliable service and exceptional Go-Anywhere performance that thousands of owners have already come to enjoy!

THIS MANUAL SHOULD REMAIN WITH THE VEHICLE IF IT IS SOLD OR TRANSFERRED





IMPORTANT HEALTH AND SAFETY INFORMATION

-The engine exhaust from this product contains chemicals known to the state of California to cause cancer, birth defects or other reproductive harm.

-Exhaust fumes are poisonous and can cause loss of consciousness and death within a short time. Always operate your machine in an area with adequate ventilation. DO NOT operate indoors.

-Gasoline and gasoline vapor is flammable and should always be handled with extreme care. Avoid areas of open flame or where other potentially high heat sources may exist when handling gasoline. Avoid inhaling gasoline vapor. If swallowed do not induce vomiting, seek immediate medical attention. If inhaled remove yourself to an area of fresh air. Seek medical attention if dizziness, headache, nausea or trouble breathing occur. Avoid contact with the skin. If skin contact is suspected wash effected area thoroughly with soap and water immediately. Seek medical attention if a rash or blister develops. Avoid eye contact, if eye contact is suspected flush with plenty of cold water. Seek medical attention immediately. If your clothes become contaminated with gasoline, change your clothes as soon as possible and store contaminated garments away from open flame or other heat sources until they can be cleaned.

-Ensure that all equipment is properly grounded prior to handling gasoline containers. Avoid static discharge from the body by touching a metal structure or known ground location.

HOW TO USE THIS MANUAL

FAILURE TO PROPERLY FOLLOW THE INSTRUCTIONS AND WARNINGS OUTLINED IN THIS MANUAL CAN RESULT IN SERIOUS INJURY OR DEATH

Important or particularly notable information contained within this manual are distinguished by the following notations:

ALERT – Notifies you of potential injury hazards, obey messages that follow this notation to avoid possible injury or death.

WARNING – Indicates a hazardous situation which if not avoided will result in serious injury or death.

NOTICE – Indicates cautions that should be taken to avoid damage to the machine or other property.

TIP – Provides information that can make a procedure easier.

IMPORTANT NOTICES

The laws regarding proper operation of your ROKON will differ depending on the model you have purchased as well as which state you reside in.

ROKON Scout and Trail-Breaker are designated for OFF ROAD USE ONLY and should never be operated on any public roadway.

ROKON Ranger is produced with limited on-road capabilities. Rangers are equipped with street legal equipment including turn signals, mirrors, horn, and high/low beam headlight. In addition, RANGER VIN number formats and EPA certifications differ from those found on the Scout and the Trail-Breaker. More information regarding proper public roadway operation can be found in the street legal section (section 11).

Check your local riding laws before riding your new ROKON.

This machine complies with all applicable Federal off-road noise level, spark arrestor and EPA laws and regulations in effect at the time of manufacture. Modifications may void compliance.

TABLE OF CONTENTS

	<u>Page#</u>
1. Location of warning and specification labels	6
2. Safety Information	7
3. Description	9
4. Specifications	12
5. Unpacking and assembly	14
6. Instruments and control functions	15
7. Pre-operation checks	20
8. Starting	22
9. Operation	23
10. Fording/Floating	26
11. Street Legal Operation	27
12. Cleaning, storage and transportation	29
13. Removal of access/maintenance panels	31
14. Periodic Maintenance and adjustment chart/instructions	33
15. Troubleshooting Guide	43
16. Component removal/installation guide	57
17. Illustrated parts guide	65
18. Wiring Diagrams	100
19. Warranty information	103
20. Emissions control system information	104
21. Torque Specs	112
22. Maintenance record/notes	113

1. LOCATION OF WARNING AND SPECIFICATION LABELS

Familiarize yourself with the location of the following warning and information labels.

1. Canadian off-highway vehicle label (Canadian machines only)
2. Oil fill warning
3. VIN label (Vehicle Identification Number) Left side below seat
4. EPA Compliance label (on front fender)
5. Street legal compliance label (Ranger only, on front fender)
6. Canadian off-highway compliance label (Canadian machines only, on front fender)
7. Shifting instructions
8. Engine specifications (includes engine serial number)



Locate and record your ROKON's identification information. Verify that these numbers match the VIN and Engine Number as listed on your Manufacturer's Statement of Origin. Doing so makes ordering replacement parts easy and also provides a reference if your vehicle is stolen.

VIN # _____

ENGINE # _____



2. SAFETY INFORMATION

A ROKON IS A MOTOR VEHICLE AND CAN BE HAZARDOUS TO OPERATE

A ROKON handles differently from other two wheeled motorcycles, a collision or fall can occur if you fail to take proper precautions or ride in terrain and conditions that exceed your abilities.

SEVERE INJURY OR DEATH can result if you do not follow these instructions:

- Read this manual and all warning labels.
- Never operate this machine in areas that exceed your capabilities as a rider.
- Children under 16 years of age should not operate this vehicle.
- Do not operate your ROKON on a public roadway or street unless it is designed to do so.
- Never operate a ROKON without wearing an approved motorcycle helmet that properly fits you. You should also wear boots, eye protection, long pants and a long sleeve shirt.
- Never operate a ROKON under the influence of drugs or alcohol.
- Never operate a ROKON at speeds that exceed your abilities or that are inappropriate for the terrain you are riding in.
- DO NOT attempt jumps, wheelies, or other stunts.
- Always inspect your ROKON each time you use it to make sure it is in safe operating condition.
- NEVER leave your ROKON in gear when you are not seated on it or when it is unattended.
- Keep both hands on the handlebars at all times during operation, keep feet on foot peg cleats while moving unless they are required to keep you upright while stationary or moving slowly.
- Ride slowly and use extra caution when operating in unfamiliar terrain.
- Do not operate in excessively rough, loose or slippery conditions until you attain the skills necessary to control the ROKON in such terrain.
- Never operate the ROKON on hills too steep for the machine or your abilities. Practice on smaller hills and inclines first.
- ROKON brakes function independently from one another; as such the majority of braking must be done with the front. Excessive rear braking can result in loss of control. Familiarize yourself

with proper braking pressures to allow reasonable stopping distance without locking/skidding the rear tire.

- Follow proper procedures for descending hills; never go downhill at high speeds.
- Never operate the ROKON in fast flowing water or in water that exceeds recommended fording depth. (See section 10)
- Maintain proper tire pressures as described in this manual.
- DO NOT exceed stated load capacities for your ROKON. Always secure cargo prior to riding, allow for additional braking distance as gross vehicle weight increases.
- Never attempt to change speed ranges while in motion or while the engine is above idle speed.
- Always make sure your ROKON is in Neutral prior to starting.
- DO NOT attempt to adjust factory settings to idle speed, belt tension/torque converter or brake system without being advised to by a ROKON factory representative.
- DO NOT refuel your ROKON while it is running or hot from riding.
- Use caution while refueling; avoid spilling fuel on hot exhaust pipes or heat shields.
- Keep your ROKON away from heat sources or open flames while refueling.
- Ground all fueling equipment prior to refueling your ROKON.



3. DESCRIPTION

LEFT SIDE



1. Front chain guard
2. Key Switch
3. Rear brake
4. Front Horizontal chain (not present on scout)
5. Front Vertical chain
6. Passenger foot peg
7. Wheel fill plug
8. Muffler
9. Autograb grease fitting (not present on Scout)
10. Operator foot peg
11. Oil fill/check plug (beneath cover)
12. CVT housing cover
13. Kickstand
14. Rear tire air valve

RIGHT SIDE

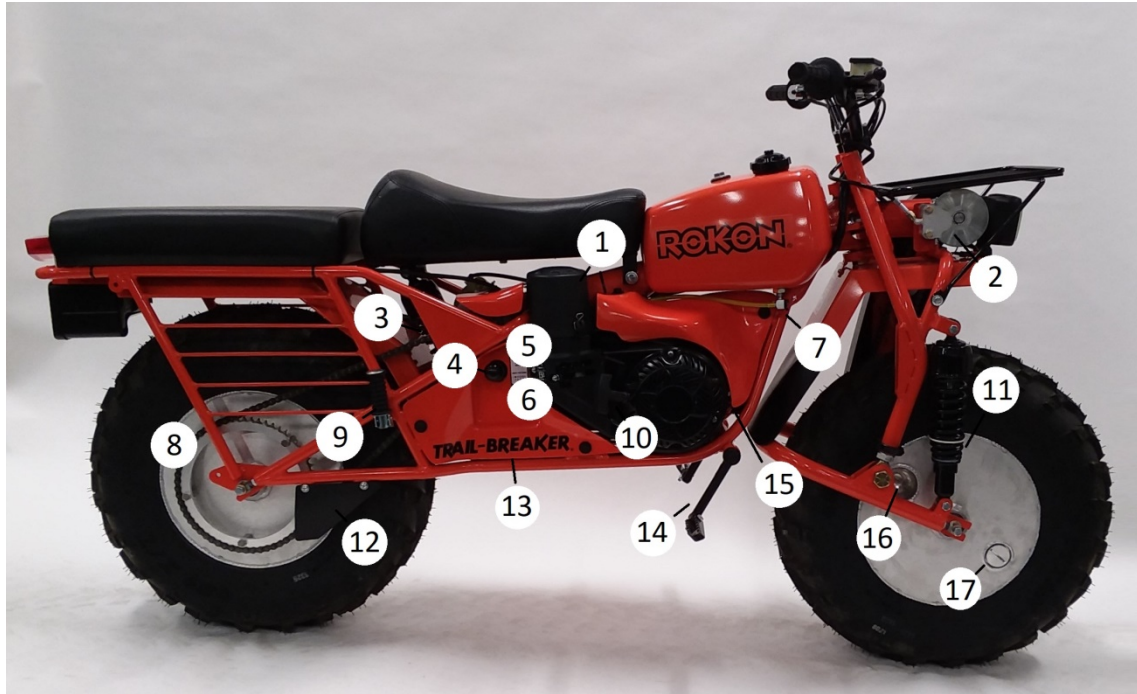

1. Air cleaner housing
2. Front Brake
3. Seat shock absorber
4. Speed range selector
5. Choke lever
6. Carburetor on-off valve
7. Fuel tank on-off valve
8. Rear chain
9. Passenger foot peg
10. Pull start handle
11. Autograb shock absorber (not present on Scout)
12. Rear chain guard
13. Battery cover
14. Operator foot peg
15. Fuse holder location
16. Front tire air valve
17. Wheel fill plug

TOP

1. Front cargo rack
2. Headlight
3. Rear brake lever
4. Rear Brake reservoir
5. Front brake reservoir
6. Front brake lever
7. Headlight switch
8. Engine kill button
9. Throttle grip
10. Fuel Tank
11. Fuel fill cap
12. Operator Seat
13. Passenger seat
14. Tail marker/brake light



4. SPECIFICATIONS

COMMON TO ALL MODELS

Drive System	Full time, Front and Rear wheel drive
Engine	Kohler, single cylinder, four stroke, air cooled
Displacement	208cc
Power Output	7 HP at 3,600 RPM
Peak Torque	12.4(9.1) Nm(ft. lb.) @ 2800 rpm
Power Transmission	Automatic torque converter into a three-gear range selector
Power Take Off	7 HP, speed proportional to throttle setting
Fuel Tank Capacity	2.69 US gal (10.0 L)
Fuel	Unleaded gasoline (87 Octane or higher)
Fuel Consumption	0.33 gal/hr (211g/PS h)
Brakes	Floating Disc type, hydraulic front and rear
Starter	Electric and pull start (automatic recoil with compression release)
Ignition	Electronic Magneto
Electrical	12 Volt AGM sealed battery
Exhaust	Muffler and U.S. Forestry approved spark arrestor
Carburetor	Fixed Main Jet Carburetor (Optional High Altitude Jet Available)
Grade Capability	60 percent
GVWR	600 lbs. (272 kg)

SCOUT

Speed Range	1st gear 0-16 MPH (24 kph) 2nd gear 0-20 MPH (32 kph) 3rd gear 0-32 MPH (51 kph)
Wheels	12 Inch Steel Spoke
Tires	8 x 12 x 25" tubeless set at 7 PSI
Wheel Base	51 Inches (129.5 cm)
Ground Clearance	13 Inches (33 cm)
Height Over Seat	30 Inches (76.2 cm)
Height Over Handlebar	39 Inches (99.1 cm)
Width	30 Inches (76.2 cm)
Length	79 Inches (200.7 cm)
Weight	218 lbs. (98.8 kg)
Fordable Water Depth	20 Inches (50.8 cm)



TRAIL-BREAKER

Speed Range	1st gear 0-16 MPH (24 kph) 2nd gear 0-20 MPH (32 kph) 3rd gear 0-32 MPH (51 kph)
Wheels	12 aluminum drum wheels with 2.69 US gal (10.0 L) fluid capacity
Tires	8 x 12 x 25" tubeless set at 7 PSI
Wheel Base	51 Inches (129.5 cm)
Ground Clearance	15 Inches (38.1 cm)
Height Over Seat	32 Inches (81.3 cm)
Height Over Handlebar	41 Inches (104 cm)
Width	30 Inches (76.2 cm)
Length	79 Inches (200.7 cm)
Weight	218 lbs. (98.8 kg)
Fordable Water Depth	22 Inches (55.9 cm)
Suspension Travel	6 Inches (15.2cm)



RANGER

Speed Range	1st gear 0-18 MPH (29 kph) 2nd gear 0-25 MPH (40 kph) 3rd gear 0-35 MPH (56 kph)
Wheels	12 aluminum drum wheels with 2.69 US gal (10.0 L) fluid capacity
Tires	8 x 12 x 25" tubeless set at 10 PSI
Wheel Base	51 Inches (129.5 cm)
Ground Clearance	15 Inches (38.1 cm)
Height Over Seat	32 Inches (81.3 cm)
Height Over Handlebar	41 Inches (104 cm)
Width	30 Inches (76.2 cm)
Length	79 Inches (200.7 cm)
Weight	222 lbs. (100 kg)
Fordable Water Depth	22 Inches (55.9 cm)
Suspension Travel	6 Inches (15.2 cm)



5. UNPACKING AND ASSEMBLY

Your ROKON comes almost fully assembled with the exception of the handlebars. They must be re-attached to the top of the front end. Remove the two 9/16" handlebar bolts that are threaded into the front end for shipment.



Straighten out the handlebars and align them to the front end. Be sure not to twist the control cables or hoses in the wrong direction. Using a 9/16" socket or wrench, tighten the handlebar bolts to secure the handlebars in place. Torque handlebar bolts to 15 – 20 ft.-lbs.

Locate the keys and fuse in your manual packet. Insert the fuse into the rubber inline fuse holder located beneath the electric starter. Close the lid to protect the fuse from dirt and moisture. Insert the key into the ignition switch.

In certain circumstances ROKON may opt to disconnect the negative battery lead prior to shipment. If this has been done, simply remove any insulator tape from your negative battery lead and reattach it to the negative battery terminal. (8mm wrench or socket required).



Add .6 QT of SAE 10W-30 engine oil to your engine via the forward fill/check plug. **NOTICE** There is no oil in the engine at the time of shipment; you **MUST** add oil prior to first startup of the engine.

Check tire pressure; verify a pressure of 7psi for off-road models and 10-12psi for street legal. **NOTICE** Front and rear tire pressure **MUST** be equal or driveline damage will occur.

6. INSTRUMENTS AND CONTROL FUNCTIONS

FUEL SYSTEM CONTROLS



Fuel Tank shut-off valve – Located on the bottom right side of the fuel tank. When open (down position), gasoline is allowed to flow from the fuel tank to the carburetor. Close this valve when storing or transporting your ROKON.



Choke lever – Located beneath the air filter housing, Choke function is used to start a cold engine and should not be operated while riding. To apply the choke, push the choke lever to the rear position until engine starts. Once engine is running the choke can be turned off by returning the lever to the forward position.

Carburetor fuel shut-off valve – Located on the right side of the bike below the choke lever. When open (forward position), gasoline is allowed to flow from the fuel line into the float bowl of the carburetor. Close this valve when storing or transporting your ROKON.



Throttle – Engine speed is increased by twisting the throttle grip on the right side of the handlebar counter-clockwise. When released, engine speed will return to idle.

BRAKE SYSTEM CONTROLS



Front Brake – The front brake lever is located on the right side of the handlebars. When brake pressure is applied the front brake will slow or stop the entire driveline. (See Safety Information page 7)



Rear Brake – Located on the left side of the handlebars. When brake pressure is applied the rear brake slows or stops the rear tire but allows the front driveline to rotate independently. (See Safety Information page 7)

SPEED RANGE CONTROL



Speed range selector knob – Located on the right side of the bike beneath the right side of the operator seat, this knob engages the desired speed range and allows you to select a neutral position. There are five positions for selecting speed ranges and neutral.

1st Gear (low range) Knob is pulled all the way out

Neutral Pos#1 In one position from 1st

2nd Gear (mid-range) Knob is in the middle position or two positions in from 1st

Neutral Pos#2 In three positions from 1st

3rd Gear (high range) knob is pushed all the way in

NOTICE the bike MUST be motionless and idling normally prior to selecting a speed range.

TIP The knob will sometimes feel stuck when you attempt to select a speed range, if this happens the gears must be synchronized. In order to do this, it is recommended that you rock the bike gently back and forth while applying pressure to the selector knob until it slides into the desired position.

WARNING ALWAYS ensure that your ROKON is in NEUTRAL prior to starting. Failure to do so can result in unintended movement upon starting.

ELECTRICAL SYSTEM CONTROLS



Key switch – The ignition key switch is located beneath the fuel tank on the left side of the bike. It has three positions, OFF, RUN, and START. In the OFF position the kill circuit is grounded and the engine will not run. The key can be removed from the bike in this position. In the RUN position, the electrical system is energized and ignition system is on. Optional accessories will be energized in this position. The start position is a momentary position

that engages the electric starter and starts the engine. **NOTICE** Do not rotate the key to this position while the engine is running.



Headlight switch/Kill Button – Located on the left side of the handlebars, the headlight switch turns the headlight and rear marker light on and off. There is also a momentary kill circuit button which can be used to quickly and easily shut the bike's engine off. Hold kill button until engine stops completely.

NOTICE Shutting off the engine in this manner will not turn off lights or optional accessories. Rotate key switch to OFF position when you are finished riding

to prevent battery depletion.

Brake light switches – With key switch in the “Run” position, switches illuminate the brake light when either brake handle is squeezed.

OPTIONAL ELECTRICAL COMPONENTS AND INSTRUMENTS



Street Legal Multifunction Switch – Installed in place of the headlight switch/kill button on street legal models, this switch performs multiple tasks.

-Parking lamp selector; P position illuminates rear marker only, H position illuminates headlight. **NOTICE** this switch **MUST** be in the P or H position in order for the bike to start and run.

-High/low beam headlight button changes the beam of the headlight; indicator lamp tells you when high beam is illuminated.

-Horn switch energizes the horn.

-Kill button shuts off the engine, hold kill button until engine stops completely.

-Turn signal operation; push switch to desired direction to illuminate flashing turn signals. Push switch inwards to stop signal.

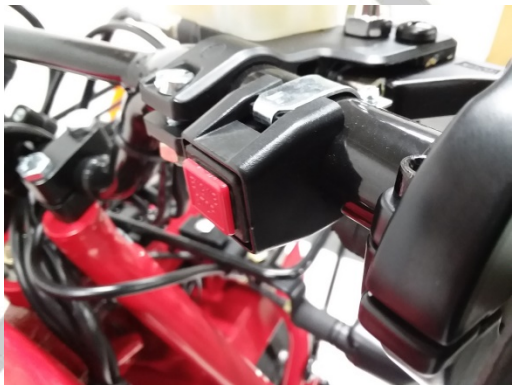

Street Legal right side kill button – Located on the right side of the handlebars on street legal models, this momentary switch serves as an extra kill button to shut off the bike's engine. Hold kill button until engine stops completely.



Speedometer – Installed at the center of the handlebars on street legal models. This unit displays current speed, distance traveled, time of day and other information. (See street legal section for further information regarding the speedometer).



Tach/Hour meter – The optional Tachometer/Hour meter is installed at the center of the handlebars. It displays total running hours when the engine is off and RPMs when the engine is running. This unit cannot be adjusted or reset.



Power Point – The optional auxiliary DC power socket is located on the right side of the bike beneath the fuel tank shut-off valve. It is energized with the key switch in the “Run” position and can be used to power accessories such as spot lights, radios, GPS units and cell phone chargers. (12V DC 10A 120W)

OTHER CONTROLS



Pull starter – In the event that you find your battery has died or is weak; the pull starter can be used to start the engine. The engine is equipped with an automatic compression release to make starting easy. **NOTICE** take care not to pull the rope all the way out while attempting to start the engine.

7. PRE-OPERATION CHECKS

ALERT

FAILURE TO INSPECT YOUR ROKON PRIOR TO OPERATION INCREASES THE POSSIBILITY OF AN ACCIDENT OR EQUIPMENT DAMAGE. ALWAYS INSPECT YOUR ROKON EACH TIME YOU USE IT TO ENSURE IT IS IN SAFE OPERATING CONDITION.

Fuel tank – Check fuel level and make sure you have a sufficient amount prior to riding. Inspect fuel condition, check for debris or moisture in the fuel tank. **NOTICE** Using very old or dirty gasoline can cause the bike to run rough and can also clog the fuel system preventing proper fuel flow or atomization. Always use fresh gasoline or fuel that has been treated with a quality stabilizer.

Engine oil – Check the level and condition of your engine oil. The oil capacity is .6 QT of 10W-30; check the level from the FORWARD dipstick/plug. Remove the plug and wipe the excess, reinsert the dipstick into the tube to check the oil level. DO NOT thread the dipstick into the tube to check level. Ensure that it is at or near the “FULL” line indicated by the dipstick. Always check your oil with the bike in a level position. **TIP** You can use a block of wood beneath the kickstand foot to stand the bike upright while you check the oil. Examine oil condition, very dark oil or oil with small metal debris present should be changed. Excessive amounts foul smelling, thin oil indicates a sticking carburetor float/needle and contamination of engine oil by gasoline. If this condition is present the problem should be addressed immediately.

Miter Box and Transmission oil - The miter box should have 2.5 oz. of EP 80W-90 gear lube oil. The transmission takes 6 oz. of EP 80W-90 gear lube oil. The transmission has a fill/check plug near the bottom of the case. There is no fill/check level for the miter box so measure before filling. Over filling of either the miter box or transmission will result in seal leakage. **TIP** A zip tie can be used to dip the miter box and transmission to determine oil level and condition.

Brakes – Evaluate the brake system by squeezing both brake levers and confirming that there is movement and adequate resistance. A spongy or soft feeling in the brake levers can indicate a leaking system, worn brake pucks, or air in the line or caliper. Inspect brake discs to make sure they float freely on the drive shafts. Stuck or seized brake discs can cause brakes to drag, overheat, lock or become noisy. Inspect brake pucks to ensure there is sufficient friction material. If irregular wear is present or if cracking or chunking of the pucks is detected they should be replaced immediately.

Throttle – Check the twist grip throttle to make sure there is minimal end play or looseness. Make sure operation is smooth and without excessive resistance. Ensure that the throttle completely returns to idle position once released.

Drive Chains – Inspect all drive chains for excessive looseness and wear. Deflection specification, lubrication and alignment guidelines are outlined in the chain adjustment procedure in section 14. Ensure that chains remain properly lubricated and free of foreign contaminants. Note any popping or grinding noises coming from the chains as this may be a sign of an improperly adjusted chain or misaligned sprocket.

Wheels and Tires – Check for proper tire pressure (5-7 off road, 7-10 on road) do not exceed tire manufacturer pressure recommendation. **NOTICE** front and rear tire pressures must be equal or driveline damage will occur. Examine the tires for excessive or irregular wear. Check for the presence of foreign objects such as nails or other debris that may have penetrated tires causing leaks. Make sure that tire beads are fully seated on wheels. **TIP** If you suspect a tire is leaking air you can coat the tire in a soapy water mixture. Leaks will be easily identified by the presence of soapy bubbles forming around the affected area.

Battery – Verify that your battery is in its proper location and is held down via the retaining bracket. Make sure it is not sitting loosely in the frame and that the positive terminal is clear of any electrically conductive material.

Lighting – It is important to verify that all lights installed on your ROKON are functioning properly. Being visible to other operators and having a working headlight at night are essential aspects of safe ROKON operation. Check headlight, tail marker and brake light prior to operating. On street legal versions, verify that your turn signals are illuminating properly and flashing at an appropriate interval.

Drive Belt – Every ROKON is equipped with a CVT (**Constantly Variable Transmission**) which consists of a front torque converter, belt and rear variable pulley. Examine your drive belt for signs of irregular wear or overheating. Check belt tension for excessive looseness. Make sure your belt and CVT faces stay clean and free of foreign contaminants. Inspect for the buildup of excessive belt debris on the frame, engine and inside CVT housing cover.

Steering and Universal joint – Turn your handlebars all the way to the left and right multiple times. Verify that you are able to steer all the way to the stop points without interference from hoses, wires or cables. The front end should move smoothly from left to right without resistance, a hesitation or inconsistent feeling can be an indication of a stuck Universal joint or a failing steering head bearing.

Fairings and other hardware – Check for the presence of all covers and fairing hardware prior to operating your ROKON, it is never advised to operate your machine without all covers and chain guards in place.

8. STARTING

It's important to familiarize yourself with all control functions, operational checks and safety warnings before operating your ROKON. Make sure you wear all required safety gear and familiarize yourself with the terrain you will be riding in.

Starting – Check for proper engine oil level and adequate fuel level prior to starting the engine.

Verify that the speed range selector is in a neutral position. You can check that the bike is in neutral by rocking it forward and back and feeling for resistance. Any resistance will indicate that the bike is in gear. You can also check to see if the rear pulley located behind the CVT cover is rotating while you move the bike. If it does not rotate the bike is in neutral.

Once you have confirmed that the bike is not in gear you can prime your fuel system. Rotate your fuel tank on-off valve to the ON (down) position. Next, move your carburetor on-off valve to the ON (forward) position. You should now see fuel flowing through the line to the carburetor. Leave your choke in the ON (rearward) position for cold engine starting.



Turn your key to the RUN position. Ensure that your battery has adequate voltage by turning on the headlight and verifying strong illumination. **On Street Legal models, the headlight switch MUST be in the "P" or "H" position in order for the bike to start!** It is strongly advised that first starts be done by hand using the pull starter. If for any reason a reservoir of liquid fuel, water or oil exists on the top of the piston it can cause a condition known as hydro-lock. Pull starting an engine

that has liquid on top of the piston greatly decreases the possibility of causing irreversible damage to internal engine components. Place your left hand on the throttle and twist it about a 1/3rd of the way. Grasp the starter handle with your right hand and pull until the engine starts. Once the engine is running, immediately reach down and move the choke to the OFF (forward) position.

After the initial start, the engine can be started by rotating the key to the START position (engage choke for a cold engine) until the engine starts. Be sure to immediately release the key from the START position once engine is running. Do not engage electric starter for more than 8 seconds at a time. If engine fails to start after 3 attempts wait for 3 minutes before attempting to start again.

It may take up to several minutes for a new bike to idle normally. Idles are set relatively low by the factory because as the engine wears in, the idle speed will increase on its own. Stay with the bike applying enough throttle to keep it running until the bike begins to idle on its own.

9. OPERATION

Selecting the proper speed range – Determining the appropriate speed range for the type of riding you will be doing is absolutely essential. Understanding which speed ranges are the best for certain tasks can prevent premature damage of the CVT pulleys and drive belt.

TIP – When attempting to change gear ranges it is not uncommon for the selector knob to feel stuck or bound. If this should happen, DO NOT attempt to force the selector into gear. Instead gently rock the bike forward and back as you apply pressure to the selector knob. Once the gears are aligned, the selector will slide easily into place.

1st This speed range is for heavy duty tasks such as going up very steep inclines or riding with a passenger. Use this speed range any time you are towing an implement, trailer or any other heavy load.

2nd The most commonly used speed range, 2nd gear is the most appropriate for general purpose use. This speed range provides a respectable amount of top-end speed also having sufficient low-end torque to perform well over many off-road obstacles.

3rd The high range of the gear box is intended only for quick transport of a relatively unloaded machine over smooth and level surfaces. **NOTICE** Improper use of 3rd range such as overloading, towing or extensive use over harsh or steep terrain can limit the lifespan of your drive belt and can also result in severe damage to the CVT system.

ALERT DO NOT leave an unmounted bike in gear; select a neutral range prior to dismounting.

Riding basics – Once the engine is running smoothly, mount the seat and settle into a comfortable stance for best balance and control function reach. Be sure that both feet can be planted flat on the ground for the best possible controllability.

Select your desired gear range and gently apply throttle until you are riding in a balanced and controlled manner. Spend some time familiarizing yourself with the handling characteristics of the ROKON on a smooth, level surface prior to attempting more complex terrain.

Put the ball of the foot, rather than the instep on the footrest. Pre-plan your route before attempting to negotiate difficult terrain. Lean into the hill when climbing switch backs.

Traversing a sloping surface requires you to properly position your weight to maintain proper balance. As you travel across or up a slope, lean your body in the uphill direction. It may be necessary to correct the steering when riding on loose surfaces by pointing the front wheel slightly uphill. When riding on slopes, be sure not to make sharp turns either up or down hill, which could cause the ROKON to turn over and potentially cause the operator and/or passenger injury.

When riding downhill, shift your weight as far to the rear and uphill side as possible. Use low gear. Whenever possible ride straight downhill. Use good judgement on limitations of grade angle. Turn into corners with the rear brake only, so as not to slide the front wheel and lose steering control. Keep throttle slightly engaged to utilize engine compression braking through the CVT system.

A ROKON handles much differently from a dirt bike or ATV. Both wheels are driven simultaneously with the same amount of power and torque. The rear wheel is not designed to freewheel or spin independently from the front. For this reason, attempting jumps or other stunts may result in roll pin breakage or severe driveline damage. Avoid spinning both tires at a high rate of speed in a low traction area before coming in contact with a high traction area (example: rapidly spinning both tires on ice before reaching bare ground or shore).



Storing/Transporting Fluid in Drum Wheels – If your bike is equipped with Drum Wheels, you can utilize them for the storing and transportation of liquids.

The fluid storage capacity of each wheel is 2.5 U.S. Gallons (9.5 Liters). To fill a wheel, rotate the filler neck to the uppermost position and remove the fill cap. **TIP** Use a wide tipped flat head screwdriver to remove the cap, the ROKON spark plug wrench can be used for this purpose.

NOTICE DO NOT overfill the wheel, vapors must be given room to expand. DO NOT transport or store liquid with water contents in freezing temperatures.

Fill the wheel until the fluid is just below the fill cap threads. Reinstall fill cap and make sure it is fully seated. To vent, loosen plug slowly when it is rotated to the topmost position.

TIP When extracting fluids from a wheel, the use of a hand transfer pump is recommended. (ROKON hand pump shown, PN 109004).



10. FORDING AND FLOATING

WARNING Water crossings can be extremely hazardous, do not attempt to ford or float your bike across swift moving bodies of water or areas where tidal currents may be present. Never attempt water crossings that exceed your abilities as a rider.

Fording - The ROKON can be used to cross slow moving shallow water of up to a maximum of 22 inches in depth. Before entering the water, choose your path carefully. Enter where there is no sharp drop off, and avoid rocks or other obstacles which may be slippery or unstable. Drive slowly and carefully. Try to avoid changing course in the middle of a stream or you may find that slippery rocks and changing currents might throw you off balance.

Floating - If the water body is over 22" in depth, shut the bike off and float your machine across (EMPTY drum wheels only). Keep the air intake out of the water to avoid flooding the combustion chamber. Always float the bike with the right hand side above water (as shown in picture below). Immediately pull start bike once crossing is completed to ensure a clear combustion chamber.



11. STREET LEGAL OPERATION

WARNING

ROKON RANGERS HAVE AN INCREASED SPEED CAPABILITY THAT ALLOWS THEM TO ATTAIN A TOP SPEED OF APPROXIMATELY 35MPH WITH A COMBINED 200LB RIDER AND CARGO LOAD (TOTAL VEHICLE WEIGHT BEARS UPON TOP SPEED). ALTHOUGH ROKON RANGER CAN BE REGISTERD AS A MOTORCYCLE, IT IS STRONGLY ADVISED THAT IT BE RESTRICTED TO USE ON ROADS WITH SPEED LIMITS NO GREATER THAN 35MPH.

THE STREET LEGAL CAPABILITY OF THE ROKON IS INTENDED FOR SHORT DISTANCES ON SECONDARY ROADS ONLY.

NEVER OPERATE ON RESTRICTED ACCESS HIGHWAYS. ALWAYS OBEY THE LAWS OF THE ROAD PERTAINING TO MOTORCYCLE OPERATION IN YOUR STATE.

DO NOT OPERATE A STREET LEGAL ROKON ON A PUBLIC ROADWAY WITHOUT POSSESSING THE PROPER LICENSE AS REQUIRED IN YOUR STATE.

Before You Ride – It is very important to analyze traffic and weather conditions prior to taking your RANGER on the street.

Understand that your machine will handle much differently on paved surfaces than it does off road.

Always wear DOT approved safety gear and whenever possible take steps to make yourself as visible as possible, it is advised that you wear brightly colored apparel or reflective materials even if you are riding in daylight.

DO NOT remove factory installed reflectors or reflective safety material.

Inspect your bike to verify that all signaling equipment including horn and turn signals are functioning properly.

Ride with your headlight on at all times whenever you are riding on the street.

Riding in traffic – Select the proper speed range while riding on the street so as not to impede regular traffic flow.

Maintain a reasonable distance between you and the vehicle in front of you.

Be aware of your surroundings at all times. In addition to use of side view mirrors, it is very important to also perform shoulder checks before changing lanes or merging.



Remember that soft shoulders rumble strips and unpaved roadways can be hazardous to any motorcycle operating on a public road. Always stay to the left of the center of your lane to avoid road debris and oil slicks, paired riding or “lane splitting” with another motorcycle is not advised and may be illegal in some states.

Speedometer Adjustment – Pressing the top button on the right side of the speedometer will switch the top display from current time to electrical system voltage.

Pressing the bottom button will cycle the bottom display from odometer, trip odometers, hours, and most recent maximum speed.

By holding down the top button alone, you will switch the display between a 12 hour and a 24 hour clock.

By holding down the bottom button alone, you will switch the measurement units between Kilometer and Miles.



All settings regarding tire circumference and sensor quantity are set by the factory.

Adjustments can be made to time of day, illumination settings and unit of measure if needed.

By holding down both buttons together on the right side of the speedometer, you will enter the adjustment mode. The top button will allow you to cycle through adjustable settings while the bottom button will perform the required changes.

12. CLEANING, STORAGE AND TRANSPORTATION

Cleaning – Keeping your ROKON clean is an essential part of periodic maintenance and can greatly extend the lifespan of your machine. Before cleaning your ROKON, be sure to cover your air filter or air cleaner housing to prevent moisture from entering your carburetor or combustion chamber.

Avoid the use of excessively high pressure nozzles or sprayers that can potentially cause damage to sensitive areas such as gasket seams, electrical connections, decals and gearbox vents. Do not spray high pressure water on drive chains. Rinse your machine thoroughly paying close attention to the bottom of the frame and the inside of the fenders. Use soapy, warm water on a clean sponge or brush to clean your ROKON. Rinse off and dry machine thoroughly using a clean terry cloth.

Standard automotive cleaner waxes can be used to polish painted surfaces and plastic fairings. Apply and remove wax according to manufactures recommendations. DO NOT leave excess wax buildup on plastic surfaces. Care must be taken to prevent wax from contacting decals, mud flaps, brake hoses and vinyl seat material. Avoid cleaners that are known to damage plastic and painted surfaces. DO NOT apply cosmetic cleaners of any kind to brake discs.

Seats can be cleaned with a light duty vinyl or leather cleaner. DO NOT use cleaners that leave an oily residue on seats, foot pegs or hand grips.

Storage – It's important to ensure that your bike is stored correctly after each use. Make sure that your ROKON is clean and dry before storing. Store in a dry location, out of direct sunlight and free of invasive critters. Use a weatherproof cover if you intend to store your machine outdoors.

If you intend to store your machine for a period of 3 months or more, additional steps must be taken to ensure that is ready to use when removed from storage. Fill your fuel tank with fresh gasoline. Add a high quality fuel stabilizer that is rated for long term storage and helps prevent ethanol breakdown. Follow mixture instructions outlined by the manufacturer. Start and run your machine for a period of at least 15 minutes, this will ensure that fresh fuel and stabilizer has made its way into the carburetor. Once you have placed your ROKON in its storage location, shut off both fuel tank and carburetor fuel flow valves. Disconnect the negative battery lead, if machine will be stored in temperatures below 32 degrees, remove battery from bike entirely and store it in a climate controlled environment. **NOTICE** – DO NOT store battery on a bare concrete floor. Keep out of reach of children. It is recommended that you apply electrical tape over exposed battery terminals while in storage to prevent accidental arcing or discharging.

Transportation – When transporting your ROKON, care must be taken to prevent damage to the machine and ensure that it arrives at its destination safely.

If you are loading your ROKON into a pickup truck or van, use a ramp or set of ramps that were designed specifically for this purpose. NEVER use boards, blocks or other homemade devices for this task. Make sure the ramp you have selected has a rated capacity capable of handling the full weight of the machine and any accessories that may be installed. (See the Specifications section to determine the weight of your machine). **WARNING** DO NOT attempt to ride your bike up a loading ramp, place your machine in neutral and push it up the ramp. Get someone to assist you with this task if required. **NOTICE** Prior to transporting your ROKON, move the fuel valves on the fuel tank and carburetor to the “OFF” position to prevent engine flooding or hydro-locking.

When securing your machine down to the surface of a trailer, truck bed or cargo area; the use of ratchet straps, turnbuckles or lever binders is recommended. Cam buckles or “cinch straps” can also be used. **TIP** Use two binders on the front of your machine and two binders on the rear for best possible retention. Attach one end of each binding device to either inside corner of the handlebars and the other ends as low as possible on either side of the cargo deck. Tighten binders until the bike is in a fully upright position and suspension (if equipped) is compressed. Attach the ends of the remaining binders to the rear section of the frame and the other ends as low as possible on the cargo deck. Avoid pinching wiring and brake hoses with binding equipment.

If you are using a “Wheel-Free” hitch tube carrier, follow the instructions provided to you by the manufacturer for loading and binding. **NOTICE** DO NOT exceed the rated capacity of the carrier or your vehicle.



13. REMOVAL OF ACCESS / MAINTENANCE PANELS

WARNING

**NEVER OPERATE YOUR ROKON WITHOUT ALL ACCESS PANELS AND CHAIN GUARDS IN PLACE.
DO NOT REMOVE ACCESS PANELS WHILE BIKE IS RUNNING.**



CVT Housing Cover (Left side) – Rotate key switch to the “OFF” position and remove key. Remove the two ½” bolts retaining the cover to the bike. Remove cover.



Battery access cover (Right side, bottom) – Place the gear selector knob in first gear position (all the way out). Remove the two ½” bolts retaining the cover to the bike. Remove cover.



Electrical access cover (Right side, above engine) – Remove the two ½” bolts retaining the cover to the bike. Remove cover. On Power Point equipped bikes, disconnect power and ground wires leading to Power Point to completely remove cover from bike.



Air Cleaner cover – Release the retaining clip holding the air cleaner cover to the base. Rotate housing clockwise until rear retaining tab is free. Remove cover.



Carburetor cover – Move the carburetor fuel lever to the “OFF” (rearward) position, move the choke lever to the “ON” (rearward) position. Remove the two 10mm nuts and the two T-20 screws retaining the cover to the engine. Remove cover. **TIP** It is easier to remove the carburetor cover once the battery access cover has also been removed.



Front chain guard – Remove the ½” bolt retaining the guard to the front end. Remove guard. **TIP** This procedure is the same for Autograb and standard front ends.

14. PERIODIC MAINTENANCE AND ADJUSTMENTS

In order to ensure the safety of the rider and protect the longevity of your ROKON, it's important to perform routine care and maintenance as described in the table below. Most of these procedures that follow are very simple and can be easily performed by the owner.

Periodic Maintenance	(Whichever comes first)		
ITEM:	Task:	Hours:	Months:
Engine oil	Check level	Before each ride	
	Change	80	3
Gearbox/Miter box oil	Check Level	80	3
	Change	320	12
Brake fluid	Inspect Condition	Before each ride	
	Check level	Before each ride	
Drive Chains	Adjust	As needed	
	Lubricate	12	1
Sprockets	Inspect Condition	12	1
Air Pre-Cleaner	Inspect Condition	12	1
	Wash/Clean	As needed	
Air Filter Element	Inspect Condition	12	1
	Replace	1200	48
Spark Plug	Inspect Condition	12	1
	Replace	1200	48
CVT Drive Belt	Inspect Condition	12	1
	Replace	1200	48
CVT Pulleys	Inspect Condition	12	1
	Clean	As needed	
Brake Discs	Inspect Condition	Before each ride	
Brake Pucks	Inspect Condition	Before each ride	
	Replace	1200	48
Brake Hoses	Inspect Condition	Before each ride	
Throttle	Check End-Play	Before each ride	
	Adjust	As needed	
Over Running Clutch (slip-joint)	Lubricate	80	3
Universal Joint	Inspect Condition	12	1
Tires	Inspect Condition	Before each ride	
	Check air Pressure	Before each ride	
Wheels	Inspect Condition	12	1
Autograb Idler Bearing (if equipped)	Lubricate	12	1
Wheel Bearings	Inspect Condition	80	3
Steering Head Bearings	Inspect Condition	80	3
Battery	Inspect condition	80	3

Drive Chain Adjustment – Chain adjustments will be one of the most frequent service items required on your ROKON. It is important to examine the chain tension and sprocket alignment before every ride. Failure to do so can result in the chains slipping off the drive sprockets or even chain breakage. The following is a procedure for chain adjustment and sprocket alignment.

Symptom: Rear chain or Scout front chain loose

1. Using a 9/16" wrench, loosen adjuster bolt lock nuts on frame tube ends or fork ends (two 9/16" wrenches will be required).
2. Loosen axle bolts slightly.
3. Rotate both sides' adjuster bolts alternately counter-clockwise to tighten the chain, maintain consistent revolutions (or fractional revolutions) on both adjusters to reach desired chain tension. (about 3/4" – 1/2" deflection at center is acceptable)
4. Tighten adjuster bolt lock nuts and axle bolts. Verify that spacer is contacting adjuster.

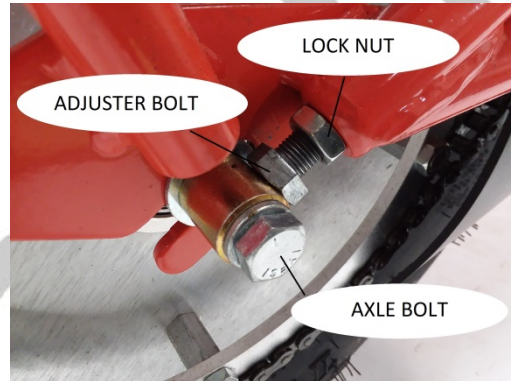

Symptom: Rear sprockets or Scout front sprockets misaligned

1. Raise the bike so that the tire is at least six inches off the ground, support it securely.
2. Loosen the adjuster bolt lock nut on the non-sprocket side. Loosen non-sprocket side axle bolt.
3. Adjust non-sprocket side adjuster bolt in or out (as required) periodically rotating the tire forward until chain is running smoothly and centered on both sprockets.
4. Tighten adjuster bolt lock nuts and axle bolts.
5. Upon completion of alignment, review chain adjustment procedure.

Symptom: Vertical chain loose (Autograb)

1. Loosen collar clamps using a 3/16" Allen wrench.
2. Using a 7/8" (or adjustable) wrench, rotate aluminum adjuster nuts at bottom of tubes counter-clockwise alternately to tighten the chain, maintain consistent revolutions (or fractional revolutions) on both nuts to reach

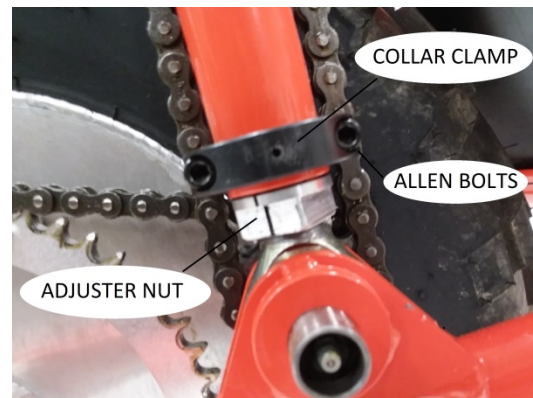

desired chain tension. (about 1/2" deflection at center is acceptable)

NOTICE Vertical chain sprocket alignment is set by the factory; altering this alignment is not advised. Adjust for tension only.

Symptom: Horizontal chain loose (Autograb)

1. Using a 9/16" wrench, loosen adjuster bolt lock nuts on swing arm tube ends (two 9/16" wrenches will be required).
2. Loosen axle bolts slightly.
3. Rotate both sides' adjuster bolts alternately counter-clockwise to tighten the chain, maintain consistent revolutions (or fractional revolutions) on both adjusters to reach desired chain tension. (about 1/4" deflection at center is acceptable)
4. Tighten adjuster bolt lock nuts and axle bolts.

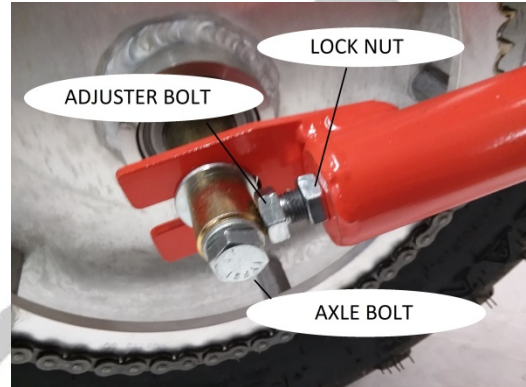

Symptom: Horizontal sprockets misaligned (Autograb)

1. Raise the front of the bike so that the tire is at least six inches off the ground, support it securely.
2. Loosen adjuster bolt lock nut on right side (shock side). Loosen right side axle bolt.
3. Adjust right side adjuster bolt in or out (as required) periodically rotating front tire forward until chain is running smoothly and centered on both sprockets.
4. Tighten adjuster bolt lock nuts and axle bolts.
5. Upon completion of alignment, review chain adjustment procedure.

Keep chains well lubricated and free of foreign material, failure to do so can result in premature chain wear and breakage. There are many different chain lubricants available and the one you chose will depend on your environment. Be sure to choose a lubricant that is tacky enough to remain on the chain without slinging off at speed. Replace with #40 Roller chain.

Idle Speed Adjustment – ROKON sets all idles specifically according to each bike. Idles are set after a 15 minute warm-up period and are all set at approximately 200 feet above sea-level.

Elevation, relative humidity, ambient temperature and oil viscosity can all affect idle speed. It is important to understand that no adjustments to the idle should be attempted on any bike unless the engine has been properly broken-in for a period of at least 3 hours. Out-of-the-box adjustments may be required if you live in an area with a nominal elevation above 4000 feet. Seasonal idle adjustments may also be required depending on temperature.

NOTICE Do not attempt to adjust idle unless engine has been warmed for 10 – 15 minutes and has still failed to idle normally.

1. Remove carburetor cover.
2. Locate idle adjustment screw on rear of carburetor above fuel bowl.
3. To increase idle speed, rotate idle adjustment screw clockwise. Rotate counter-clockwise to decrease.

TIP Use a small right-angle driver with a Phillips head.

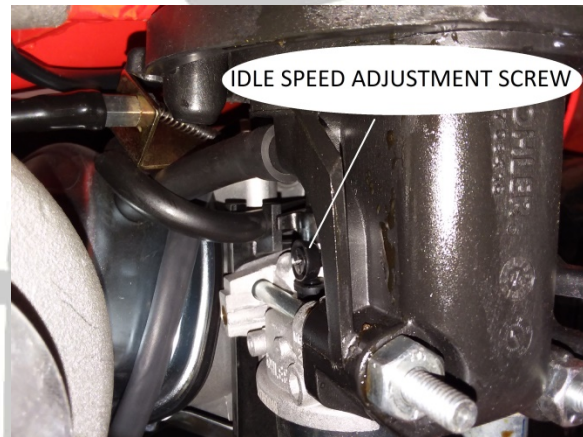

Idle is too LOW if engine is stalling after warm-up.

Idle is too HIGH if the clutch can be heard engaging or if the transmission makes a clicking or grinding sound when a gear change is attempted.

NOTICE A high idle that results in a clicking noise from the transmission WILL result in premature failure of driveline components. If possible, set idle on the low side to avoid this.

Throttle end-play adjustment – Throttle end-play is set by the factory to provide you with optimal throttle response and proper throttle release spring tension. As your machine ages, it may be necessary to adjust throttle end-play to make up for excess throttle “dead zone” and improve throttle response.



NOTICE DO NOT use throttle end-play adjustment to adjust idle speed.

1. Slide dust boot off of throttle cable adjuster.
2. Loosen lock nut.
3. Rotate inner adjuster collar until excess end-play is removed. DO NOT adjust beyond the point of increasing engine speed governed by idle speed screw.

Brake System Maintenance – The brake system on all ROKON models is a relatively maintenance-free setup. It is important however to perform periodic checks to ensure that it is working properly and is free of foreign contaminants.

NOTICE Use ONLY DOT-3 or 4 brake fluid in all ROKON brake systems.

1. Inspect reservoirs for proper fluid level and condition. Check reservoirs for leaks and ensure that fill caps are properly seated.
2. Inspect brake lines for leaks, cracking, kinking or other damage.
3. Inspect calipers for leaks or damage.
4. Inspect brake pucks for irregular wear.



If hydraulic brakes feel spongy, “bleeding” them may help. Do not pressure bleed with more than 5 PSI.

1. Orient handlebars to ensure brake reservoirs are level. Remove cover of malfunctioning brake reservoir and fill with hydraulic fluid to maximum line. (Throughout bleeding process, do not allow fluid to drop below minimum line.) Replace cover but leave loose to allow reservoir to vent during bleeding.
2. Find the corresponding brake caliper to the reservoir you have filled. Loosen upper bleeder screw on caliper.
3. Grasp brake lever and slowly engage brake to bleed. Air bubbles and hydraulic fluid will flow out of the loosened bleeder screw.

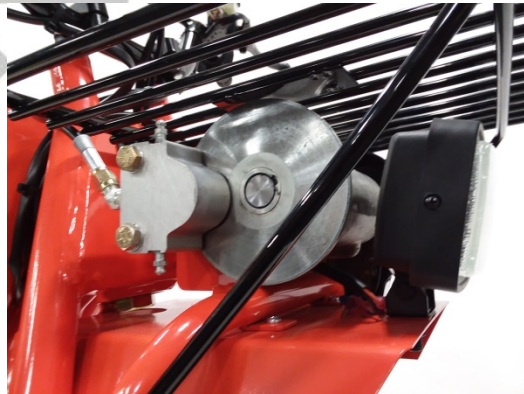

4. Before brake lever is fully seated, re-tighten bleeder screw on caliper. Allow brake lever to reset to resting position.
5. Refill brake reservoir as necessary.
6. Repeat steps 1-5 until bleeder screw is releasing a constant flow of hydraulic fluid with no air bubbles. Brake handle will feel firm when bleeding is complete.
7. Tighten reservoir cover until it is sealed and seated.

The floating brake disc must be free to move axially so that the moveable puck will push against the fixed puck. Otherwise, unequal wear or bending of the disc will result. Lubricate the shafts and keys where the brake discs ride with anti-seize. Proper clearance between the puck and the disc is .010" minimum per side to a maximum of .030" per side when new. Discs must be free of dirt and grease for maximum life and braking action.

Replacement of the brake "pucks" or friction material is performed as follows:

1. Be sure no pressure is applied to the caliper during puck replacement.
2. Use a ½" wrench and/or socket to remove the two SAE grade 8 hex bolts. This will dismount and disassemble the caliper, exposing the Pucks for replacement.
3. Remove the flat head screws that hold the Pucks in place on each side of the caliper. Remove Pucks from Housing and Dead Side Housing.
4. Place new Pucks into Housings. Replace flat head screws; tighten to hold Pucks in place. (Note: Screw head will fit into recessed area of Puck. Be sure only friction material will contact disc when reassembled.)
5. Reassemble caliper and mount as before.

Changing the oil – Oil changes should be performed every 6 months (more often if bike experiences frequent extended usage).

1. Set bike in a level position. **TIP** You can set the bike in a level position by placing a block of wood beneath the kickstand foot.
2. Remove the CVT housing cover.

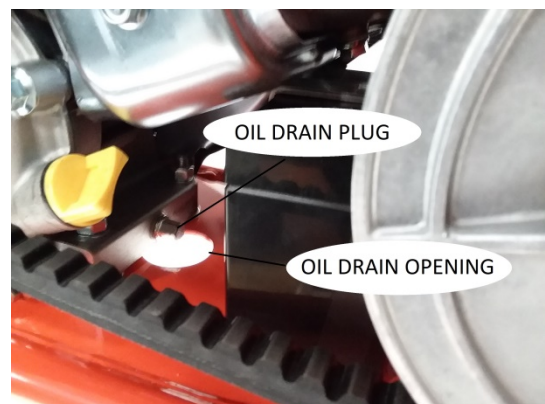

3. Place a container beneath the frame drain hole.
4. Using a 10mm wrench, remove the oil drain plug at the back of the engine. Be careful not to lose the sealing washer on the drain plug.
5. Once all old oil has been drained, replace drain plug. DO NOT over-torque.
6. Refill with .6 QT of fresh 10W-30 engine oil from the FORWARD fill/check hole.
7. Start engine and check for leaks.

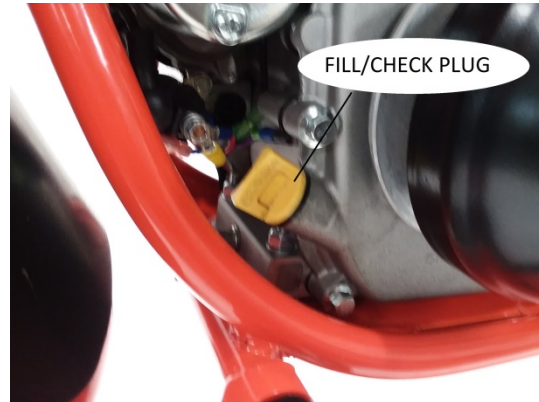

Replacing or cleaning the spark plug – ALERT Use caution servicing the spark plug while the engine is hot.

TIP to ensure quick and easy removal of the spark plug, a purpose-built ROKON spark plug wrench is highly recommended (PN 108059).

It is important to inspect the spark plug every 100 hours of operation. When replacing or cleaning the spark plug, make sure you set the gap on the plug to .76 mm or .030 in. Replace with Champion RC12YC or equivalent.



Air filter inspection and replacement – NOTICE Operation of the engine without the air cleaner in place can lead to severe engine damage.



It is recommended that the air cleaner be inspected before each ride. It is also advised that the pre-cleaner element be washed regularly as needed. Remove the pre cleaner from the paper element filter and wash with warm water detergent. Rinse thoroughly until all traces of detergent is gone. Allow to dry completely before reinstalling over paper element. Replace paper element every 100 hours (more frequently if excessively dusty conditions are present).

Changing miter box and transmission oil – The transmission and miter box oil should be checked every 3 months. It should be changed annually.

There is a check plug on the rear of the transmission that can be removed to verify oil level and condition. Drain the transmission oil by removing the drain plug at the bottom of the transmission case.

The miter box has a single fill/check/vent plug on top of the housing that can be used for filling and checking. Draining of miter box oil can be accomplished by using an automotive fluid extractor with a narrow, rigid tube. Alternatively, the miter box can be removed from the front end and drained upside-down.

TIP You can use a zip tie to dip the miter box to verify condition and level.

Atop both the miter box and transmission is a vented plug, it is important to make sure this vent is moving properly by pulling the tip out and verifying that the internal spring seats it back in place. Failure of this vent can lead to internal pressurization of the gear box and seal leakage.

Use EP 80W-90 gear oil in both the miter box and transmission.

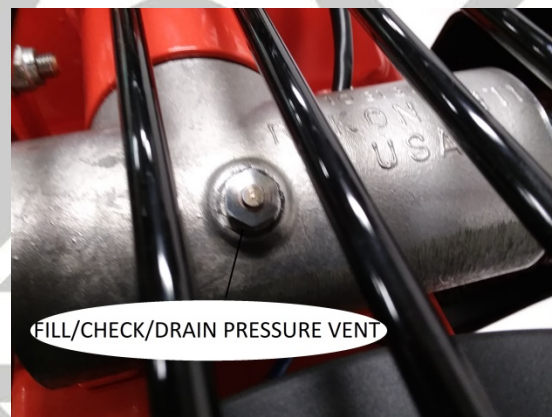
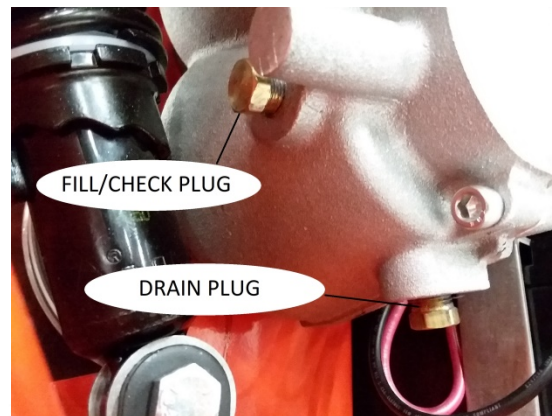

Miter Box capacity – 2.5oz

Transmission capacity – 6oz

NOTICE DO NOT OVERFILL, Seal leakage will occur.

Over-running clutch lubrication – The over-running clutch (or slip joint) is an essential component to the operation of a ROKON. It allows the front wheel to rotate faster than the rear when riding through a sharp turn on a hard surface. If kept properly lubricated, this component will work seamlessly and will require very little maintenance. Locate the inspection and lubrication holes in the main frame tube under the front seat. Lubricate the over-running clutch with a few drops of 80W-90 gear oil into the inspection hole every six months.

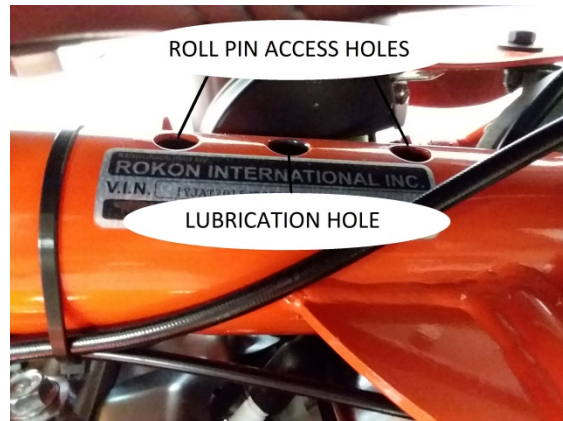

Autograb idler sprocket bearing lubrication (Ranger and Trail-Breaker only) – There is one grease fitting on Ranger and Trail-Breaker models, it is located on the left side of the bike at the end of the idler sprocket shaft. It is recommended that this grease point gets at least one pump of #2 Lithium grease every 20 hours (more often when frequently exposed to deep mud or water crossings).

Belt Replacement – The drive belt should be inspected for wear and proper tension regularly. Replacement should be determined based on wear. To replace, firmly grasp the belt and tug it up and down until the faces of the rear driven pulley separate slightly and allow for additional belt slack. Once the belt is loose it can be removed by prying one edge off the top of the rear pulley and rotating the pulley clockwise until the belt walks itself out of the groove. Installation of a new belt is performed by seating the belt in place on the torque converter (forward pulley) and starting the belt seat at the top of the rear pulley. Firmly grasp the rear pulley and rotate it clockwise until the belt walks itself into place and seats fully in the groove of the rear pulley.



Tire inspection and pressure check – ALERT it is highly advised that any tire replacement or repairs be performed by an experienced tire technician.

Inspect tires before each ride. Note the condition of the tread and check for the presence of foreign objects that may have punctured the tire.

Tire pressures should be set between 5-7psi off road and 7-10psi on road. **NOTICE** Front and rear tire pressure **MUST** be equal or driveline damage will occur. **DO NOT** exceed tire manufacturer's recommended pressure setting.



Fuse Replacement – Replace fuse with standard 25 amp ATO blade type fuse. Fuse holder is located on the front of the engine beneath the starter solenoid.

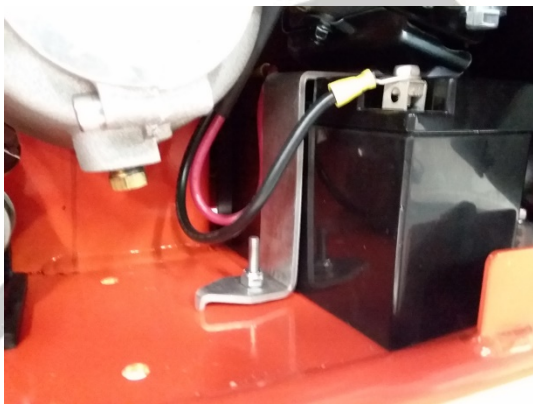

Replacing the battery – ALERT ALWAYS disconnect the negative battery terminal before attempting to remove the battery from its hold-down location.

The battery condition should be checked regularly by verifying the output voltage. It should remain between 11 and 13 volts. Voltage can be checked with a voltage meter or multi meter, on street legal models, the voltage can be checked via the speedometer.

If you suspect your battery is in need of replacement, disconnect negative battery terminal and remove the battery hold-down bracket. Remove the battery from the bike and disconnect positive terminal. Replace with a quality AGM battery of the same group size and dimensions.

TIP A battery tender can be used to prolong the life of your battery and ensure consistent cranking amperage during periods of inactivity. Refer to battery tender manufacturer recommendations to find a unit that is right for your application.

15. TROUBLESHOOTING GUIDE

This section is for diagnosing and addressing potential problems with your ROKON. It is strongly suggested that the user consult this guide prior to contacting the factory should you have a problem. Many of the problems outlined within are relatively simple to address and reading this guide can prevent unnecessary purchase and replacement of parts that may be in perfect working order. Should you need help diagnosing a problem or replacing a component, our technical support team is ready to assist you. Call the factory at (603) 335-3200, tech support hours are Mon-Fri 8AM to 4PM EST. You can also email your troubleshooting questions to info@rokon.com and one of our technical advisors will respond as soon as possible.

Please refer to the warranty information in sections 19 and 20 prior to addressing problems.

Troubleshooting Index

SUBJECT	PAGE#
Engine	44
Fuel/Air System	46
Transmission and Driveline	47
Miter Box and Universal Joint	48
Chain Drive	49
CVT System (Clutch, Belt and Rear Pulley)	50
Brakes	51
Electrical and Ignition System	53
Handling and Performance	55

TROUBLESHOOTING GUIDE

ENGINE (See also KOHLER CH270 manual)

Symptom: Fails to start but does rotate (see also FUEL/AIR SYSTEM)

**Causes listed in order of probability*

- If pull starting, Key switch is not turned to "on" position
- If street legal, headlight switch is not in the P or H position
- Little or no fuel flow (see FUEL/AIR SYSTEM)
- Choke lever in incorrect position (a cold engine will need to be choked while a warm engine may not)
- Little or no throttle is being applied for startup (twist throttle grip 1/3 of the way open when starting)
- Excess fuel in combustion chamber (flooded engine)
- Poor fuel condition
- Weak, inconsistent or no ignition spark (see ELECTRICAL AND IGNITION SYSTEM)
- Intake passage obstructed
- Excess oil has collected on top of piston (can occur after the bike has been on its side)
- Low compression (Internal problem)

Symptom: Will not start or rotate

- Liquid fuel or oil in combustion chamber (Hydro locked from flooding, overturned bike or stuck float)
- Electric starter gear has failed to disengage
- Foreign object is jammed against flywheel/starter teeth
- Water in combustion chamber (Hydro locked from water fording/crossing)
- Significant internal engine problem

Symptom: Starts but does not stay running (see also FUEL/AIR SYSTEM)

- Choke lever in incorrect position (move choke lever to "off" position after engine has started)
- Engine cold; apply 1/3 throttle while running for 1 minute to warm (repeat as necessary)
- Idle speed is too low (see IDLE ADJUSTMENT in section 14)
- Inadequate fuel flow (see FUEL/AIR SYSTEM)
- Poor fuel condition
- Weak or inconsistent ignition spark (see ELECTRICAL AND IGNITION SYSTEM)
- Clogged/dirty air filter or intake passage obstructed
- Improper carburetor jet installed for operating altitude
- Low oil level or incorrect viscosity is preventing smooth engine operation
- Low compression (spark plug may not be fully seated / head gasket, valve or piston ring failure)

Symptom: Idle is too high

- Idle setting is incorrect (see IDLE ADJUSTMENT in section 14)
- Throttle endplay improperly adjusted
- Air filter is not seated correctly, or intake passage is drawing too much air
- Improper carburetor jet for operating altitude installed

Symptom: Misses or backfires

- Choke lever in incorrect position (move choke lever to "off" position after engine has started)
- Poor fuel condition
- Inadequate fuel flow (see FUEL/AIR SYSTEM)
- Weak or inconsistent ignition spark (see ELECTRICAL AND IGNITION SYSTEM)
- Excess fuel in combustion chamber (flooded engine)
- Ignition timing incorrectly set
- Low compression (Internal problem)

Symptom: Overheating

**Causes listed in order of probability*

- Machine is being over-worked or improperly used
- Blocked/dirty cooling fins or obstructed cooling passages
- Improper speed range selected for riding conditions
- Low oil level or incorrect viscosity is preventing smooth engine operation
- Improper carburetor jet installed for operating altitude
- Inconsistent ignition spark (see ELECTRICAL AND IGNITION SYSTEM)
- Stuck brake caliper/ drive line failure is creating additional load on engine
- Low compression (Internal problem)

Symptom: Lacking power or stalling under load

- Little or no fuel flow (see FUEL/AIR SYSTEM)
- Improper speed range selected for riding conditions
- Excessive throttle cable end-play (see section 14)
- Poor fuel condition
- Weak or inconsistent ignition spark (see ELECTRICAL AND IGNITION SYSTEM)
- Air filter is not seated correctly, or intake passage is drawing too much air
- Clogged/dirty air filter or intake passage obstructed
- Machine is being over-worked or improperly used
- Inadequate engine lubrication
- Improper carburetor jet installed for operating altitude
- Stuck brake caliper/ drive line failure is creating additional load on engine
- Low compression (internal problem)

Symptom: Excessive smoke from exhaust

- Engine is cold
- Choke lever in incorrect position (move choke lever to "off" position after engine has started)
- Poor fuel condition
- Clogged/dirty air filter or intake passage obstructed
- Weak or inconsistent ignition spark (see ELECTRICAL AND IGNITION SYSTEM)
- Excess fuel in combustion chamber (flooded engine)
- Oil introduced into combustion chamber or inside exhaust (can occur after the bike has overturned)
- Improper carburetor jet for operating altitude installed
- Internal engine problem

Symptom: Smoking (other)

- Engine block /cooling fins are wet or dirty
- Engine overheating
- Foreign contaminants or plastic/rubber components are burning/melting on hot engine surface
- Electrical component has shorted or failed (see ELECTRICAL AND IGNITION SYSTEM)
- Oil viscosity incorrect, oil is contaminated with fuel
- Leaking exhaust gasket
- Head gasket or piston ring failure

Symptom: Excessive or irregular noise

- Leaking exhaust system or gasket
- Foreign object is contacting flywheel/starter teeth or pull starter cup
- Low oil level or incorrect viscosity
- Air filter is not seated correctly, or intake passage is drawing too much air
- Machine is being over-worked or improperly used
- Improper speed range selected for riding conditions
- Stuck brake caliper/ drive line failure is creating additional load on engine
- Significant internal engine problem

Symptom: Leaking oil

***Causes listed in order of probability**

- Engine oil fill cap(s) not tight, O ring is missing or is contaminated with debris
- Drain plug not tight or is missing sealing washer
- Leaking from exhaust or carburetor after bike has over turned (top end is full of oil)
- Oil reservoir is overfilled
- Oil viscosity is incorrect
- Clogged crankcase ventilation tube
- Block side cover bolts loose
- Block side cover gasket failure
- Crankshaft oil seal failure
- Valve cover gasket failure
- Head gasket failure

FUEL/AIR SYSTEM (See also KOHLER CH270 manual)

Symptom: Fuel is not flowing adequately from fuel tank valve

- Inadequate fuel level
- Tank valve is in incorrect position (must be in down position in order for fuel to flow)
- Tank valve is only partially open (must be 90 degrees down from the "off" position)
- Carburetor valve is in "off" position (both valves must be "on" in order for fuel to flow from the tank)
- Fill cap vent is clogged or obstructed
- Screen inside fuel tank has become clogged
- Defective fuel tank valve

Symptom: Fuel flow is not stopped by moving fuel tank valve to the "off" position

- Defective fuel tank valve

Symptom: Fuel is not flowing adequately between tank valve and carburetor

- Fuel filter has become clogged
- Fuel line clogged or deteriorated

Symptom: Fuel is not entering float bowl at an adequate rate

- Carburetor fuel valve is in "off" position
- Carburetor fuel valve is only partially open
- Defective carburetor fuel valve
- Carburetor fuel passage has become clogged

Symptom: Float bowl is filled with debris or solid material

- Poor fuel condition
- Crystallization of ethanol present in fuel has occurred (usually after a long period of inactivity)
- Defective or deteriorated fuel filter
- Deteriorated fuel line

Symptom: Engine is filling with fuel or oil is contaminated with fuel

- Fuel float or needle is stuck allowing fuel to pass into the engine in liquid form
- Engine has been run for an extended period with choke partially or fully "on"
- Bike has been left with both fuel valves in the "on" position
- Clogged/dirty air filter or intake passage obstructed
- Improper carburetor jet for operating altitude installed

Symptom: Air filter is becoming contaminated with fuel

- Liquid fuel has filled the intake passage (can occur if the bike has overturned or the float becomes stuck)
- Internal engine problem

Symptom: Engine is running too rich with choke in the “off” position

***Causes listed in order of probability**

- Poor fuel quality
- Clogged/dirty air filter or intake passage obstructed
- Improper carburetor jet for operating altitude installed

Symptom: Engine is running too lean with choke in the “off” position

- Poor fuel quality
- Little or no fuel flow (see FUEL/AIR SYSTEM)
- Improper carburetor jet for operating altitude installed
- Air filter is not seated correctly, carburetor gaskets missing, loose carburetor or air cleaner base

Symptom: Carburetor is leaking gasoline

- Fuel line is not fully seated on input nipple
- Liquid fuel has filled the intake passage (can occur if the bike has fallen over or the float becomes stuck)
- Float bowl O ring is deteriorated or has failed
- Float bowl retaining screw O ring has deteriorated or has failed
- Float bowl drain plug O ring has deteriorated or has failed
- Defective carburetor fuel valve

TRANSMISSION AND DRIVELINE

Symptom: Grinding sound or lurching motion when changing gears

- Idle is set too high (see IDLE ADJUSTMENT in section 14)
- The gear change is being attempted while or too soon after the throttle is being applied
- The gear change is being attempted while the bike is moving
- Idler bearing on forward CVT pulley is stuck or has failed (see CVT SYSTEM)
- Forward CVT pulley is stuck open and not releasing the belt (see CVT SYSTEM)
- Low gear oil level or incorrect viscosity is preventing smooth gearbox operation

Symptom: Unable to change gears

- Idle is set too high (see IDLE ADJUSTMENT in section 14)
- The gear change is being attempted while or too soon after the throttle is being applied
- The gear change is being attempted while the bike is moving
- Idler bearing on forward CVT pulley is stuck or has failed (see CVT SYSTEM)
- Forward CVT pulley is stuck open and not releasing the belt (see CVT SYSTEM)
- Low gear oil level or incorrect viscosity is preventing smooth gearbox operation
- Defective shift control rod detent bearing/ spring
- Shift gear selector key is broken or out of place
- Shift gear selector shaft has failed

Symptom: Shift gear selector knob moves but has decreased or no effect

- Defective shift control rod detent bearing/ spring
- Shift gear selector key is worn, broken or out of place
- Shift gear selector shaft has failed

Symptom: Does not stay in gear

- Defective shift control rod detent bearing/ spring
- Shift gear selector key is worn, broken or out of place
- Main gears on selector shaft are worn or broken
- Shift gear selector shaft has failed

Symptom: No rear wheel drive

- Broken shear pin on rear output sprocket

**Causes listed in order of probability*

Symptom: No front wheel drive (see also MITER BOX AND UNIVERSAL JOINT)

- Broken shear pin on forward output shaft at slip joint
- Broken shear pin on main drive shaft at slip joint
- Broken shear pin on forward output miter gear(s) (inside transmission)
- Broken or worn miter gear(s)
- Defective or worn slip joint

Symptom: Bucking or vibrations present when bike is cornering (see also MITER BOX AND UNIVERSAL JOINT)

- Unequal Tire Pressures
- Defective or worn slip joint
- Broken or worn miter gear(s)

Symptom: Transmission overheating

- Low gear oil level or incorrect viscosity is preventing smooth gearbox operation
- Gearbox vent is clogged or defective
- Machine is being over-worked or improperly used
- Stuck brake caliper/ drive line failure is creating additional load on gearbox
- Failure of internal components is causing excessive friction

Symptom: Transmission leaking

- Gearbox is overfilled with oil
- Gearbox vent is clogged or defective
- Oil viscosity is incorrect
- Foreign material has penetrated the area between a shaft and an oil seal lip
- An oil seal has deteriorated or has failed
- Silicone case sealer has deteriorated or has failed

Symptom: Excessive or irregular noise (see also MITER BOX AND UNIVERSAL JOINT)

- Low gear oil level or incorrect viscosity is preventing smooth gearbox operation
- Stuck brake caliper/ drive line failure is creating additional load on gearbox
- Failure of internal components is causing excessive noise

Symptom: Seized, locked

- Stuck brake caliper/ drive line failure is creating additional load on gearbox
- Gearbox has run out of oil and internal components have been overheated
- Failure of internal components is preventing proper rotation

MITER BOX AND UNIVERSAL JOINT

Symptom: No front wheel drive (see also TRANSMISSION AND DRIVELINE)

- Broken shear pin on forward output sprocket
- Broken shear pin on input shaft at universal joint
- Broken shear pin on miter gear(s) (inside miter box)
- Broken or worn miter gear(s)

Symptom: Bucking or vibrations present when bike is cornering (see also TRANSMISSION AND DRIVELINE)

- Universal joint is failing to move smoothly on the main drive shaft (must slide freely in and out)
- Defective or worn universal joint
- Broken or worn miter gear(s)

Symptom: Overheating

***Causes listed in order of probability**

- Low gear oil level or incorrect viscosity is preventing smooth miter box operation
- Miter box vent is clogged or defective
- Machine is being over-worked or improperly used
- Failure of internal components is causing excessive friction

Symptom: Leaking

- Miter box is overfilled with oil
- Miter box vent is clogged or defective
- Oil viscosity is incorrect
- Foreign material has penetrated the area between a shaft and an oil seal lip
- An oil seal has deteriorated or has failed

Symptom: Excessive or irregular noise (see also TRANSMISSION AND DRIVELINE)

- Low gear oil level or incorrect viscosity is preventing smooth miter box operation
- Stuck brake caliper/ drive line failure is creating additional load on gearbox
- Failure of internal components is causing excessive noise

CHAIN DRIVE

Symptom: Excessively loose (see DRIVE CHAIN ADJUSTMENT in section 14)

- Chain has stretched (readjust according to procedure in section 14)
- Improperly adjusted chain tensioner bolt or nut (see DRIVE CHAIN ADJUSTMENT in section 14)
- Chain requires the removal of a link
- Chain is worn beyond use and requires replacement

Symptom: Excessively tight (see DRIVE CHAIN ADJUSTMENT in section 14)

- Improperly adjusted chain tensioner bolt or nut (see DRIVE CHAIN ADJUSTMENT in section 14)
- Foreign material stuck in sprocket grooves or between chain rollers
- Loose axle bolt has caused chain to tighten beyond adjustment position

Symptom: Excessive or irregular noise

- Chains are too loose or too tight (see above)
- Sprockets misaligned (see DRIVE CHAIN ADJUSTMENT in section 14)
- Lack of lubrication or improper chain lubricant applied
- Foreign material stuck in sprocket grooves or between chain rollers
- Chain is worn beyond use and requires replacement
- Sprocket hardware loose (drum wheel only)

Symptom: Fails to maintain proper tension

- Improperly adjusted chain tensioner bolt, lock nut or tube nut
- Sprockets misaligned (see DRIVE CHAIN ADJUSTMENT in section 14)
- Lack of lubrication or improper chain lubricant applied
- Loose axle bolt has caused chain to tighten or loosen beyond adjustment position
- Foreign material stuck in sprocket grooves or between chain rollers
- Chain is worn beyond use and requires replacement
- Miter box or gear box mounting hardware loose
- Sprocket hardware loose (drum wheel only)

**Causes listed in order of probability*

Symptom: Fails to stay on sprocket (derailment)

- Sprockets misaligned (see DRIVE CHAIN ADJUSTMENT in section 14)
- Loose axle bolt has caused chain to tighten or loosen beyond adjustment position
- Foreign material stuck in sprocket grooves or between chain rollers
- Lack of lubrication or improper chain lubricant applied
- Chain requires the removal of a link
- Chain is worn beyond use and requires replacement
- Miter box or gear box mounting hardware loose
- Sprocket is bent or has damaged teeth

Symptom: Chain separates or breaks

- Lack of lubrication or improper chain lubricant applied
- Foreign material stuck in sprocket grooves or between chain rollers
- Master link has failed and requires replacement
- Chain is worn beyond use and requires replacement
- Sprocket is bent or has damaged teeth

Symptom: Chains rusty or dry

- Lack of lubrication or improper chain lubricant applied

CVT SYSTEM (CLUTCH, BELT AND REAR PULLEY)

Symptom: Loose belt

- Belt worn and in need of replacement
- Secondary pulley has failed to close completely
- Engine has moved out of position and requires readjustment / alignment

Symptom: Tight belt

- Primary pulley has failed to fully disengage
- Engine has moved out of position and requires readjustment / alignment

Symptom: Dark residue or buildup on friction faces of pulley(s)

- Belt is being overheated by misuse or by selecting the improper speed range
- Excessive moisture or contaminants present on belt surface
- Belt worn and in need of replacement

Symptom: Burning rubber or plastic smell

- Belt is being overheated by misuse or by selecting the improper speed range
- Primary pulley is being overheated by misuse or by selecting the improper speed range
- Excessive moisture or contaminants present on belt surface
- Belt worn and in need of replacement
- Drive line failure is creating additional load on CVT system (see TRANSMISSION AND DRIVELINE)
- Secondary pulley has failed to close completely

Symptom: Chattering or clicking sound emitted by primary drive pulley

- Chattering or clicking noise is normal as pulley approaches engagement speed
- Foreign objects, dirt or debris inside primary pulley
- Chattering or clicking throughout power band indicates failure of internal components on primary pulley
- Primary pulley ramp plate retaining hardware loose

Symptom: Squealing

**Causes listed in order of probability*

- Belt is being overheated by misuse or by selecting the improper speed range
- Excessive moisture or contaminants present on belt surface
- Belt worn and in need of replacement
- Primary pulley has failed to fully engage
- Drive line failure is creating additional load on CVT system (see TRANSMISSION AND DRIVELINE)
- Secondary pulley has failed to close completely

Symptom: Primary pulley fails to fully engage

- Foreign objects, dirt or debris inside primary pulley
- Failure of internal components on primary pulley
- Primary is unable to fully engage under load due to misuse or by selecting the improper speed range
- Secondary pulley has failed to open completely

Symptom: Secondary fails to open fully

- Foreign objects, dirt or debris inside secondary pulley
- Failure of main bushing on secondary pulley
- Secondary is unable to fully engage under load due to misuse or by selecting the improper speed range
- Primary pulley has failed to fully engage

Symptom: Belt is spinning too fast while at idle

- Idle is set too high (see IDLE ADJUSTMENT in section 14)
- Idler bearing on primary pulley is stuck, contaminated with debris or has failed
- Engine has moved out of position and requires readjustment / alignment
- Primary pulley is stuck in engagement position and not releasing the belt

Symptom: Belt wears unevenly

- Belt is being overheated by misuse or by selecting the improper speed range
- Excessive moisture or contaminants present on belt surface
- Engine has moved out of position and requires readjustment / alignment

Symptom: Ineffective or decreased performance after fording/floating

- Belt is wet, allow time to dry
- Excessive contaminants present on belt surface
- Foreign objects, dirt or debris inside pulleys

BRAKES

Symptom: Excessive or irregular noise

- Foreign contaminants, debris or moisture on brake puck surface
- Brake disc is not moving freely on shaft or key
- Flash rust or corrosion on brake disc
- Brake pucks worn and in need of replacement
- Brake caliper is not disengaging completely

Symptom: Lacking brake lever pressure (spongy)

- Air in brake system; bleed according to procedure outlined in section 14
- Caliper piston is open and needs to be pumped back to closed position (pump brake lever)
- Fluid is leaking from the system or a bleeder screw is open
- Brake fluid level is low
- Brake pucks are worn and in need of replacement
- Faulty brake caliper
- Faulty master cylinder

**Causes listed in order of probability*

Symptom: Front brake ineffective

- Air in brake system; bleed according to procedure outlined in section 14
- Fluid is leaking from the system
- Brake fluid level is low
- Brake pucks are worn and in need of replacement
- A bleeder screw is open
- Faulty brake caliper
- Faulty master cylinder
- Broken shear pin on front output shaft

Symptom: Rear brake ineffective

- Air in brake system; bleed according to procedure outlined in section 14
- Fluid is leaking from the system
- Brake fluid level is low
- Brake pucks are worn and in need of replacement
- A bleeder screw is open
- Faulty brake caliper
- Faulty master cylinder
- Broken shear pin on rear output sprocket

Symptom: Locked up (bike will not move when pushed or is hard to push)

- Brake disc is not moving freely on shaft or key
- Foreign contaminants, debris or moisture on brake puck surface
- Brake pucks have broken or fallen out of place
- Faulty brake caliper
- Faulty master cylinder
- Drive line failure (see TRANSMISSION AND DRIVELINE)

Symptom: Disc will not move freely on shaft

- Flash rust or corrosion on brake disc
- Lack of lubrication has seized brake disc to the shaft (lubricate with anti-seize)
- Shaft or key is corroded or damaged

Symptom: Pulsation feedback is present in brake lever

- Flash rust or corrosion on brake disc
- Foreign contaminants, debris or moisture on brake disc surface
- Brake disc is not moving freely on shaft or key
- Worn or warped brake disc

Symptom: Leaking caliper

- A bleeder screw is open
- Faulty bleeder screw
- Piston O-ring has deteriorated or has failed

Symptom: Leaking hose or fitting

- Loose fitting
- Bronze sealing washer (at master cylinder) has deteriorated or has failed
- Thread sealant (at caliper) has deteriorated or has failed
- Fitting has failed
- Hose has been punctured, has become deteriorated or has failed

Symptom: Leaking master cylinder

**Causes listed in order of probability*

- Reservoir is over-filled with brake fluid
- Reservoir cap is not fully tightened
- Diaphragm has deteriorated or has failed
- O-ring at master cylinder reservoir has deteriorated or has failed
- Faulty master cylinder

Symptom: Deteriorated master cylinder diaphragm

- Poor quality or incorrect grade brake fluid
- Dirty or contaminated brake fluid

ELECTRICAL AND IGNITION SYSTEM (See also KOHLER CH270 manual)

Symptom: No electrical voltage (key "on" or "off")

- Battery dead
- Blown fuse
- Battery disconnected
- Fault caused by exposed or disconnected wire

Symptom: Low electrical voltage

- Battery is not sufficiently charged
- Battery is not holding a sufficient charge
- Battery is not receiving a proper charge from the stator or voltage regulator

Symptom: Continually blowing fuses

- Incorrectly rated fuse installed
- Accessory plugged into power point (if equipped) exceeds the amperage demand of the fuse
- User installed aftermarket accessory (if equipped) exceeds the amperage demand of the fuse
- Fault caused by a failed or malfunctioning electrical component (lights, starter, key switch, accessory)
- Fault caused by exposed or disconnected wire

Symptom: Battery will not hold charge

- Battery is old or defective
- Parasitic discharge, caused by exposed wire or accessory that has a full time electrical draw
- Not receiving proper voltage output from regulator
- Not receiving proper voltage output from the stator

Symptom: Battery will hold an external charge but is not being recharged by bike

- Blown fuse
- Poor battery ground
- Not receiving proper voltage output from regulator
- Not receiving proper voltage output from the stator

Symptom: Nothing happens when key is rotated to "Start" position

- Battery is not sufficiently charged or is dead
- Blown fuse
- Fault caused by exposed or disconnected wire
- Faulty ignition switch
- Faulty starter relay
- Faulty starter
- Engine will not rotate (see ENGINE)

Symptom: Electric starter slow or fails to start engine

***Causes listed in order of probability**

- Battery is not sufficiently charged
- Battery is old or defective
- Faulty starter
- Engine is not rotating freely (see ENGINE)

Symptom: Headlight inoperable

- Blown fuse
- Battery dead
- Key switch is not in the "on" position
- Defective headlight bulb
- Poor main harness ground
- Defective headlight switch
- Defective key switch
- Fault caused by exposed or disconnected wire

Symptom: Tail/Marker light inoperable

- Blown fuse
- Battery dead
- Key switch is in the "off" position
- Defective taillight bulb
- Poor tail light ground
- Defective headlight switch
- Defective key switch
- Fault caused by exposed or disconnected wire

Symptom: Brake light does not illuminate when levers are squeezed

- Defective taillight bulb
- Poor tail light
- Defective brake light switch
- Fault caused by exposed or disconnected wire

Symptom: Pressing kill button and/or rotating key to the "off" position fails to shut engine off

- Poor main harness ground
- Poor engine harness ground
- Fault caused by exposed or disconnected wire
- Defective handlebar kill button
- Defective street legal multifunction switch (if equipped)
- Defective key switch

Symptom: Turn signals fail to flash or flash erratically (Street legal)

- Faulty flasher unit
- Defective turn signal bulb
- Incorrect turn signal bulb installed
- Poor main harness ground
- Fault caused by exposed or disconnected wire
- Defective street legal multifunction switch

Symptom: Horn inoperable or emits irregular sound (Street legal)

- Body of horn is contacting structure of bike and preventing proper sound emittance
- Horn power lead is exposed or disconnected
- Poor main harness ground
- Defective horn
- Defective street legal multifunction switch

**Causes listed in order of probability*

Symptom: Speedometer inoperable or is not reading correct speed (Street legal)

** For additional speedometer troubleshooting, refer to speedometer directions in manual packet*

- Blown fuse
- Pickup sensor requires adjustment
- Dirt or debris on pickup sensor
- Damaged or disconnected sensor cable
- Poor main harness ground
- Exposed or disconnected speedometer full time power lead
- Exposed or disconnected speedometer switched power lead
- Defective pickup sensor
- Defective speedometer

Symptom: Power point inoperable (Optional)

- Key switch is in the "off" position
- Blown fuse
- Device or accessory inoperative
- Fault caused by exposed or disconnected wire
- Poor power point ground
- Moisture or debris inside power point is preventing good contact
- Defective power point

Symptom: Tach/Hour meter displaying erratic or inconsistent RPMs (Optional)

- Fault caused by exposed or disconnected wire
- Poor tach/hour meter ground
- Weak or inconsistent ignition spark
- Incorrect or faulty tach/hour meter

Symptom: Weak, inconsistent or no ignition spark

- Key switch is in the "off" position
- If street legal, headlight switch is not in the P or H position
- Fouled or dirty spark plug
- Spark plug gap incorrect (see section 14)
- Spark plug is worn and in need of replacement
- Deteriorated spark plug boot
- Poor contact between ignition wire and spark plug
- Deteriorated ignition wire
- Fault caused by exposed or disconnected wire (kill switch wires, tach/hourmeter wire)
- Ignition coil air gap is set incorrectly
- Defective ignition coil
- Defective handlebar kill button
- Defective street legal multifunction switch
- Defective or broken flywheel ignition magnet

HANDLING AND PERFORMANCE

Symptom: Bike bucks or hesitates

- Front tire pressure is lower than the rear (see section 14 for correct tire pressure settings)
- Defective or worn slip joint
- Engine problem (see ENGINE)
- CVT system problem (see CVT SYSTEM)
- Transmission or driveline problem (see TRANSMISSION AND DRIVELINE)

Symptom: Bike pulls to the right or left at speed

***Causes listed in order of probability**

- Tire pressure is set too low (see section 14 for correct tire pressure settings)
- Axle is adjusted too far to the left or right

Symptom: Steering feels hard or sticks

- Universal joint is failing to move smoothly on the main drive shaft (must slide freely in and out)
- Defective or worn slip joint (see also TRANSMISSION AND DRIVELINE)
- Damaged or worn steering head bearing

Symptom: Steering does not seem to reach its maximum angle (left or right)

- Wires, hoses or control cables are being pinched between fuel tank and front end
- Damaged or worn steering head bearing
- Universal joint is failing to move smoothly on the main drive shaft (must slide freely in and out)

Symptom: Suspension seems too stiff/too soft

- Shocks should be adjusted to suit rider comfort
- Inappropriate tire pressure set for riding conditions

Symptom: Left/Right vibration in handlebars while riding at speed

- Inappropriate tire pressure set for riding conditions
- Imbalanced tire
- Chain problem (see CHAIN DRIVE)
- Front drive problem (see MITER BOX AND UNIVERSAL JOINT)
- Tire is worn and in need of replacement
- Tire is not fully seated on rim

Symptom: Up/Down vibration while riding at speed

- Inappropriate tire pressure set for riding conditions
- Imbalanced tire
- Chain problem (see CHAIN DRIVE)
- Transmission or driveline problem (see TRANSMISSION AND DRIVELINE)
- Tire is worn and in need of replacement
- Tire is not fully seated on rim

16. COMPONENT REMOVAL / INSTALLATION GUIDE

Please refer to the warranty information in sections 19 and 20 prior to removing components.

FUEL TANK (please see health and safety information before attempting this procedure)

Removal

1. Move fuel tank valve to the “off” position
2. Disconnect fuel line from the fuel tank valve (use a rag or container to catch any fuel that remains in the fuel line).
3. Remove fuel tank retaining bolt (top of fuel tank, $\frac{3}{4}$ ” bolt head) and washers.
4. Gently remove fuel tank from bike, avoid pinching wires or cables against front end.

OPERATOR SEAT/SHOCK

Removal

1. Remove forward 9/16” retaining bolts connecting seat plate to frame on either side.
2. Remove 7/16” retaining nuts connecting lower seat shock mount to frame. (on “retro-seat” equipped bikes, remove rear mounting bolt from left side mounting tab).
3. Carefully remove seat and shock assembly from bike.

PASSENGER SEAT

Removal

1. Remove four 7/16” retaining bolts from underside of seat (forward-left bolt may require a thin open-ended 7/16” wrench).
2. Remove seat from bike

WHEELS/TIRES

Removal

1. Ensure that bike is in Neutral
2. Raise and secure the bike using an ATV jack so that both tires are completely off the ground.
3. Loosen drive chain (see chain adjustment procedure in section 14).
4. Locate and remove master-link from drive chain using a narrow flat head screw driver.
5. Remove drive chain from sprockets
6. Loosen axle retaining bolts and carefully remove wheel/tire assembly from bike.

Installation

1. Unscrew axle retaining bolts so that a sufficient amount of space exists between outside washer/spacer and axle edge.
2. Install wheel/tire assembly in place sliding axle retaining bolts into mounting forks.
3. Using two 9/16” wrenches, snug both axle bolts simultaneously (do not tighten fully).
4. Reinstall chain over sprockets and reconnect ends using master-link.
5. Follow chain adjustment and sprocket alignment procedure outlined in section 14.

CVT PULLEYS

Forward pulley (clutch) removal

1. Remove belt using procedure outlined in section 14.
2. Remove $\frac{1}{2}$ ” retaining bolt and locking tab.

3. Gently pull edges of fixed (inner) pulley face away from the engine. **TIP** (It may be necessary to pry between fixed pulley face and engine block with a crowbar or large screwdriver. If this is required, avoid the outer edge of the inner pulley face and instead try to pry from the hub).
4. Gently remove clutch from engine.

Installation

1. Clean engine crankshaft end and lubricate with anti-seize.
2. Install clutch on shaft.
3. Install retaining bolt, make sure locking tab is oriented properly and bend corners over bolt to prevent rotation. (the use of a new locking tab is recommended)
4. Reinstall belt.

Rear Pulley removal

1. Remove belt using procedure outlined in section 14.
2. Loosen rear pulley set screws (3) around the hub using an Allen wrench.
3. Gently pull edges of movable (inner) pulley face away from the transmission. **TIP** (It may be necessary to pry between the hub and the bike's frame with a pry bar or large screwdriver. If this is required, avoid the outer edge of the inner pulley face and instead try to pry from the hub).
4. Gently remove rear pulley from transmission.

Installation

1. Clean transmission input shaft and lubricate with anti-seize.
2. Install rear pulley on shaft, seat to retaining ring.
3. Tighten rear pulley set screws (3) around the hub using an Allen wrench.
4. Reinstall belt.

MITER BOX

Removal

1. Unplug and remove headlight from front fender
2. Remove chain guard
3. Loosen front drive chain (see chain adjustment procedure in section 14)
4. Separate drive chain by removing the master-link and remove the chain from the sprockets.
5. Remove the brake caliper by first removing the two ½" bolts and lock nuts. Move caliper out of the way
NOTICE DO NOT disconnect brake line.
6. Remove brake disc by sliding it off of the shaft.
7. Remove the two miter box retaining bolts (1/2") holding the miter box to the fork.
8. Gently slide the miter box and universal joint forward and out of the front end tube.

Installation

1. Align the universal joint key slot to the corresponding key on the main drive shaft.
TIP using a cardboard toilet paper roll around the universal joint during installation can aide the alignment process; just be sure to remove it with a knife once the miter box has been properly installed.
2. Seat the miter box in place and reinstall the retaining bolts.
3. Clean and lubricate brake disc shaft with anti-seize and reinstall brake disc.
4. Reinstall brake caliper, pump brake lever to rebuild brake pressure before use.
5. Reinstall drive chain and connect ends using the master-link.
6. Adjust chains according to the procedure in section 14.
7. Reinstall chain guard.
8. Reinstall headlight.

TRANSMISSION

Removal

1. Place the transmission in 3rd range (all the way in).
2. Remove operator seat and shock (see **OPERATOR SEAT/SHOCK**) or rear cargo rack (if equipped).
3. Remove rear CVT pulley (see **CVT PULLEYS**).
4. Loosen rear chain (see chain adjustment procedure in section 14).
5. Move rear chain out of the way, support it against frame.
6. Rotate driveline so that the rear spring pin on the slip-joint is aligned with the rear spring pin hole. (see slip-joint image in section 14 entitled 'Over-running clutch lubrication') **TIP** this can be accomplished by rolling the bike forward or back until aligned.
7. Using a spring pin punch, drive the spring pin out of the slip joint from the top down.
8. Remove the 3 transmission retaining bolts from the frame mounting plate and the forward retaining bolt from the upper gusset by the air cleaner (all ½" hardware).
9. Move brake caliper and bracket out of the way **NOTICE DO NOT** disconnect brake line.
10. Gently slide the transmission back and out of the main frame tube. **TIP** if the transmission does not slide easily out of the main frame tube, a rubber mallet can be used to break it free. **NOTICE DO NOT** strike the transmission case with a hard faced hammer.
11. Maneuver the transmission out of the frame. **TIP** place a towel or blanket on the rear fender to prevent scratching or scuffing.

Installation

1. Place the transmission in 3rd range (all the way in).
2. Clean and lubricate brake disc shaft with anti-seize and reinstall brake disc.
3. Maneuver the transmission into place within the frame of the bike. **TIP** place a towel or blanket on the rear fender to prevent scratching or scuffing.
4. Gently slide the transmission forward into the main frame tube ensuring that the forward output shaft fully seats into the slip-joint boss.
5. Rotate driveline so that the rear spring pin hole on the slip-joint is aligned with the corresponding hole on the transmissions forward output shaft. **TIP** this can be accomplished by rolling the bike forward or back until aligned.
6. Using a spring pin punch, install the spring pin connecting the slip joint to the forward output shaft.
7. Position the brake caliper over the disc and align bracket holes with transmission mounting holes.
8. Reinstall the 3 transmission retaining bolts through the frame mounting plate and the forward retaining bolt through the upper gusset by the air cleaner. Pump brake lever to rebuild brake pressure before use.
9. Reinstall drive chain and connect ends using the master-link. Readjust according to procedure outlined in section 14.
10. Reinstall rear CVT pulley (see **CVT PULLEYS**).
11. Reinstall operator seat and shock.

DRIVELINE

Removal

1. Remove fuel tank (see **FUEL TANK**).
2. Remove operator seat (see **OPERATOR SEAT**)
3. Remove passenger seat (see **PASSENGER SEAT**).
4. Remove rear wheel (see **WHEELS/TIRES**).
5. Remove rear fender (see **FENDERS**).
6. Remove transmission (see **TRANSMISSION**).
7. Remove miter box (see **MITER BOX**).
8. Remove the two 7/16" carrier bearing retainer bolts from the frame (in front of the fuel tank post).
9. Slide the driveline out from the rear of the main frame tube.

TIP It is possible to remove the transmission and driveline as a single unit once the rear fender and wheel have been removed.

Installation

1. Slide driveline into the rear of the main frame tube.
2. Align the carrier bearing block bolt holes with the corresponding holes in the main frame tube. **TIP** a small screw driver or pick can be used to line up bolt holes.
3. Loosely install the two 7/16" carrier bearing retainer bolts DO NOT tighten yet.
4. Install transmission (see **TRANSMISSION**)
5. Tighten carrier bearing retainer bolts.
6. Install miter box (see **MITER BOX**).
7. Install rear fender.
8. Install rear wheel (see **WHEELS/TIRES**).
9. Install passenger seat.
10. Install operator seat.
11. Install fuel tank

BRAKES

Master Cylinder removal

1. Place the bike in an upright and level position
2. Remove the throttle grip, hand grip and any other accessories on the handlebar.
TIP Do not alter the position of the throttle end-play adjuster when removing the throttle grip.
3. Disconnect the brake light switch.
4. Separate the brake hose from the master cylinder by removing the 7/16" hose fitting. Use a rag to catch any brake fluid that leaks from the hose or the brake fluid reservoir. Place the hose in an upright position to prevent excessive fluid loss.
5. Remove the screw and retaining nut clamping the master cylinder to the handlebar.
6. Gently pry open the retaining clamp using a flat head screwdriver and slide the master cylinder assembly off of the handlebar.

Installation

1. Gently pry open the retaining clamp using a flat head screwdriver and slide the master cylinder assembly onto the handlebar.
2. Install the screw and retaining nut clamping the master cylinder to the handlebar.
3. Connect the brake hose to the master cylinder.
4. Perform brake bleeding procedure outlined in section 14.
5. Reinstall throttle grip, hand grips and any other accessories mounted to the handlebar.

Caliper removal

1. Grasp the brake disc and pull it towards the live side of the caliper (the side with the bleeder screws) to open the caliper.
2. Note hardware orientation and remove the two 1/2" bolts and nuts holding the caliper to the front end/brake bracket.
3. Slide the caliper off the disc and remove it from the bike.
4. Separate the brake hose from the caliper by removing the 7/16" hose fitting. Use a rag to catch any brake fluid that leaks from the hose or the caliper. Place the hose in an upright position to prevent excessive fluid loss.
5. If servicing brake pucks, use a narrow flat head screw driver to remove the brake puck retaining screws.

Installation

1. Connect the brake hose to the caliper.

2. Slide the caliper over the disc and line up the mounting holes with the bracket/front end holes.
3. Install the two ½” bolts, nuts and associated washers
4. Perform brake bleeding procedure outlined in section 14.

MUFFLER/EXHAUST PIPE

Removal

1. Loosen the two 10mm head pipe retaining bolts.
2. Remove the two ½” muffler retaining nuts from behind the muffler.
3. Lower the muffler from the retaining studs and slide the muffler assembly off of the head pipe and out of the frame.
4. Remove the two 10mm head pipe retaining bolts.
5. Remove the head pipe from the engine.

Installation

1. Install the head pipe on the engine and loosely install the two 10mm head pipe retaining bolts (do not tighten yet).
2. Insert the muffler assembly into the frame and slide the exhaust pipe over the head pipe.
3. Install the muffler mounting tabs onto the retaining studs and install the two 1/2” retaining nuts.
4. Completely tighten the 10mm head pipe retaining bolts.

FENDERS

Front Fender removal

1. Disconnect and remove the headlight.
2. Remove the 3 fender retaining screws/nuts from the front end.
3. Remove the fender from the front end.

Rear Fender removal

1. Remove the rear wheel (**see WHEELS/TIRES**)
2. Remove the muffler assembly (**see MUFFLER/EXHAUST PIPE**)
3. Remove the passenger seat (**see PASSENGER SEAT**)
4. Remove the two muffler mounting bolts and nuts.
5. Remove the six fender retaining screws and nuts.
6. Remove the fender from the bike.

Installation

1. Line the fender up with the mounting holes in the frame.
2. Install the six fender mounting screws and nuts.
3. Install the two muffler mounting bolts and nuts.
4. Install the passenger seat.
5. Install the muffler assembly (**see MUFFLER/EXHAUST PIPE**).
7. Install the rear wheel (**see WHEELS/TIRES**).

CARBURETOR/INTAKE PASSAGE

(Please see health and safety information before attempting this procedure)

Removal

1. Move both fuel valves to the “Off” position.
2. Remove the air cleaner cover and air filter (see section 13).
3. Remove the carburetor cover (see section 13).
4. Using a 13mm socket, remove the two carburetor/intake passage retaining nuts.

5. Remove the intake passage. **TIP** separate the PCV ventilation hose from the intake housing instead of the engine valve cover, this makes reinstallation much easier.
6. Separate the fuel line from the carburetor fuel inlet nipple. Use a rag to catch any fuel that remains in the fuel line.
7. Note the position of the throttle cable clamp on the throttle cable and loosen the clamp screw.
8. Remove the throttle cable from the cable clamp and pull it through the throttle arm.
9. Remove the carburetor from the engine.

Installation

1. Install the carburetor onto the intake mounting studs. Ensure that all gaskets are present, clean and properly oriented. Ensure that choke lever is present and in its proper position.
2. Insert the throttle cable through the return spring and the throttle arm hole.
3. Insert the throttle cable through the retaining clamp ensuring that it is positioned where it was prior to removal.
4. Tighten the cable clamp screw.
5. Check throttle end-play, adjust if necessary (see end-play adjustment procedure outlined in section 14).
6. Install the fuel line over the fuel inlet nipple.
7. Install the intake passage; be sure to reconnect the PCV hose.
8. Install the two 13mm retaining nuts.
9. Install the carburetor cover.
10. Install the air filter and air cleaner cover.

PULL STARTER/COOLING DUCT

Pull starter removal

1. Remove the 3 8mm pull starter bolts.
2. Remove the pull starter assembly.

Cooling duct removal

1. Remove the carburetor cover (see section 13).
2. Remove the two 10mm bolts from the bottom of the cooling duct housing.
3. Remove the two 10mm nuts from the top of the cooling duct housing.
4. Remove the cooling duct housing.

FLYWHEEL (see also KOHLER CH270 Manual)

Removal

1. Remove the cooling duct (see **PULL STARTER/COOLING DUCT**)
2. Remove the flywheel retaining nut, pull starter cup and cooling fins.
3. Note the position of the ignition coil and remove the two 10mm ignition coil retaining bolts. Remove the ignition coil.
4. Use a puller to separate the flywheel from the crankshaft. (Refer to KOHLER manual for proper tool recommendation).
5. Remove the flywheel.

Installation

1. Install the flywheel onto the crankshaft.
2. Install the cooling fins, pull starter cup and flywheel retaining nut.
3. Torque flywheel nut to 655 In-lbs.
4. Install the ignition coil, set air gap to .010.
5. Install the cooling duct/pull starter.

ELECTRIC STARTER

Removal

1. Disconnect the negative battery terminal from the battery.
2. Disconnect the positive battery lead and control wire from starter relay.
3. Remove the cooling duct (**see PULL STARTER/COOLING DUCT**)
4. Remove the flywheel (**see FLYWHEEL**)
5. Remove the 2 10mm electric starter mounting bolts.
6. Remove the starter.

HANDLEBARS

Removal

1. Remove/disconnect throttle grip.
2. Remove/disconnect brake master cylinders (**see BRAKES**).
3. Remove/disconnect kill/headlight switch (**see ELECTRICAL COMPONENTS**)
4. Disconnect the brake light switches from master cylinders.
5. Remove the two handlebar-to-fork mounting bolts. (rearmost bolts that thread into the fork tubes)
6. Remove handlebar from front end.

FRONT END (Autograb and Standard)

Removal

1. Remove front wheel (**see WHEELS/TIRES**).
2. Remove front fender (**see FENDERS**).
3. Remove front brake caliper (**see BRAKES**).
4. Remove miter box (**see MITER BOX**).
5. Remove handlebars (**see HANDLEBARS**).
6. Remove the two 1 1/8" front end mounting bolts.
7. Remove the front end from the bike.

Installation

1. Line the front end steering bearings up with the holes in the steering head.
2. Install the two 1 1/8" front end mounting bolts, torque to 200 ft-lbs.
3. Install handlebars.
4. Install miter box (**see MITER BOX**).
5. Install front brake caliper (**see BRAKES**)
6. Install front fender.
7. Install front wheel. (**see WHEELS/TIRES**)

ELECTRICAL COMPONENTS

(Disconnect negative battery lead prior to performing these procedures)

Headlight removal

1. Disconnect electrical leads.
2. Remove mounting nut from stud.
3. Remove headlight.

Tail light removal

1. Disconnect electrical leads.
2. Remove mounting screws/nuts.
3. Remove tail light assembly.

Headlight/kill switch removal

1. Remove Philips head screw from retainer clamp.
2. Separate retaining clamps from housing.
3. Open housing and loosen cable retaining screws.
4. Remove wires from switch assembly.

Key/Ignition switch removal

1. Remove battery cover, disconnect negative battery lead.
2. Remove key from switch.
3. Remove CVT housing cover (see section 13).
4. Disconnect main engine electrical harness from back of switch, remove ground plug.
5. Remove switch retaining nut and lock washer from key switch housing.
6. Remove key switch from bike.

Voltage Regulator removal

1. Remove the electrical access cover (see section 13).
2. Disconnect the two A/C leads from the outer terminals.
3. Disconnect the D/C lead from the center terminal.
4. Remove the two 7/16" voltage regulator retaining bolts.
5. Remove voltage regulator.

Stator removal (see also KOHLER CH270 Manual)

1. Remove cooling duct (see PULLSTARTER/COOLING DUCT)
2. Remove flywheel (see FLYWHEEL)
3. Disconnect two A/C leads from outer terminals on voltage regulator.
4. Remove the four 10mm stator retaining bolts.
5. Remove the stator.

Main Harness removal

1. Remove fuel tank (see FUEL TANK)
2. Remove operator seat (see OPERATOR SEAT)
3. Remove passenger seat (see PASSENGER SEAT)
4. Loosen miter box mounting bolts and slide miter box forward (see MITER BOX)
5. Disconnect brake switch leads.
6. Disconnect headlight/kill switch leads.
7. Disconnect headlight leads, slide headlight leads out from between fork and miter box.
8. Disconnect tail light leads.
9. Disconnect main power lead (below fuel tank).
10. Disconnect main ground lead (by air cleaner).
11. Cut any zip ties retaining harness to the frame and remove the main harness.

Power Point removal (if equipped)

1. Remove electrical access cover (see section 13).
2. Disconnect power leads to power point.
3. Remove plastic retaining nut on back of power point.
4. Remove power point.

17. ILLUSTRATED PARTS GUIDE

INDEX OF ILLUSTRATIONS

SECTION	PAGE	NOMENCLATURE
17-1	66	Chain/Links
17-2	67	Decals
17-3	68	Electrical
17-4	69	Street Legal Components
17-5	71	Engine and components
17-6	74	Frame and components
17-7	76	Standard Front Fork (Scout)
17-8	77	Autograb Front Fork (Trail-Breaker and Ranger)
17-9	79	Front Cargo Rack
17-10	80	Fuel Tank
17-11	81	Exhaust system
17-12	82	Handlebars and Brakes
17-13	84	Brake Caliper
17-14	85	Operator Seat
17-15	86	Passenger Seat
17-16	87	CVT Drive Pulley (Clutch)
17-17	88	CVT Driven Pulley (Rear Pulley)
17-18	89	Transmission External
17-19	90	Transmission Internal
17-20	93	Miter Box
17-21	94	Driveline
17-22	95	Wheel (Aluminum Drum)
17-23	96	Wheel (Steel Spoke)
17-24	97	Tow Bars
17-25	98	Rear Cargo Rack
17-26	99	Sidecar

17-1 CHAIN/LINKS

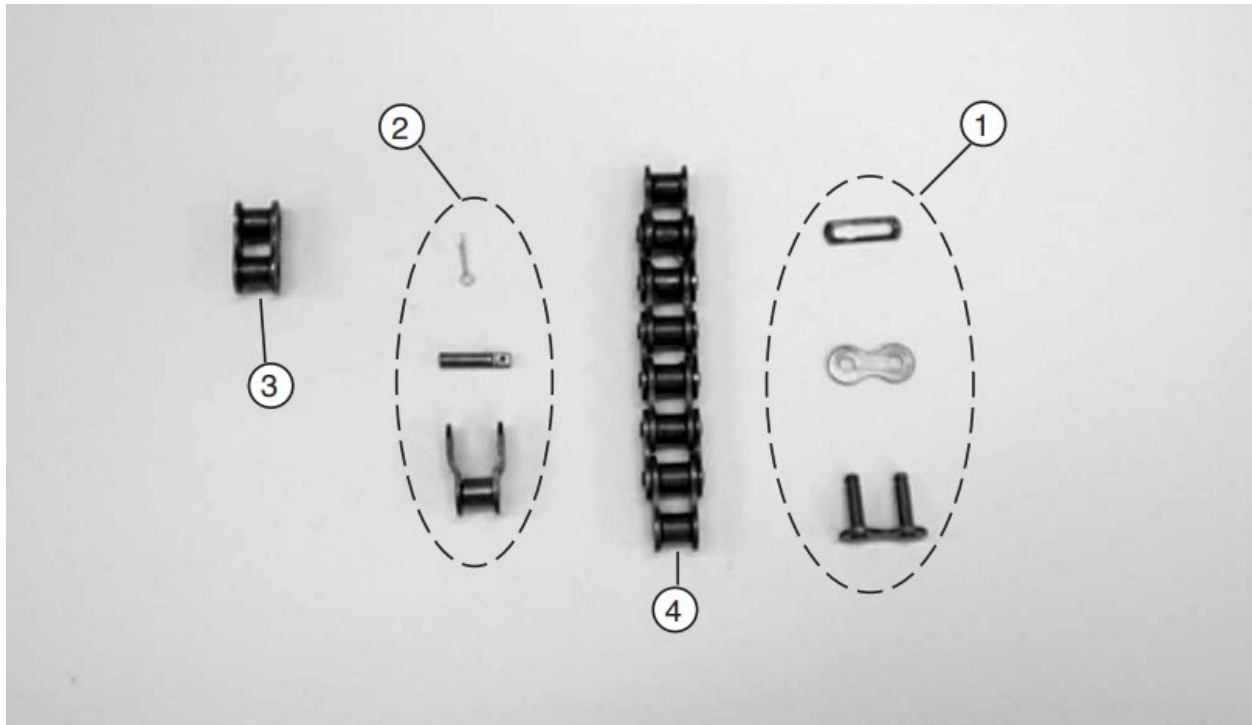

ITEM	PART NUMBER	DESCRIPTION	QTY
1	100356	Master Link	2 - 3
2	100355	Offset Link	AS NEEDED
3	100354	Full Link	AS NEEDED
4	108984	Chain Length	AS NEEDED
NS	101568A	Front Chain 107P	1 (Scout Only)
NS	101570A	Rear Chain 117P	1
NS	108946	Chain, Horizontal	1 (Autograb)
NS	108947	Chain, Vertical	1 (Autograb)
NS	101576	Chain, Ranger Rear 119P	1
NS	101575	Chain, Ranger Vertical	1

17-2 DECALS



ITEM	PART NUMBER	DESCRIPTION	QTY
1	108040	Decal, TRAIL-BREAKER in Red	2
2	108039	Decal, TRAIL-BREAKER in Black	2
3	108044	Decal, ROKON in Red	2
4	108988	Decal, Oil Warning	1
5	101626	Decal, Shift Instructions	1
6	108972	Decal, Handlebar, ROKON	1
7	108043	Decal, SCOUT in Red	2
8	101595	Decal, SCOUT in Black	2
9	108041	Decal, RANGER in Black	2
10	108045	Decal, ROKON in Black	2
11	103138	Decal, MOTOTRACTOR	2

17-3 ELECTRICAL

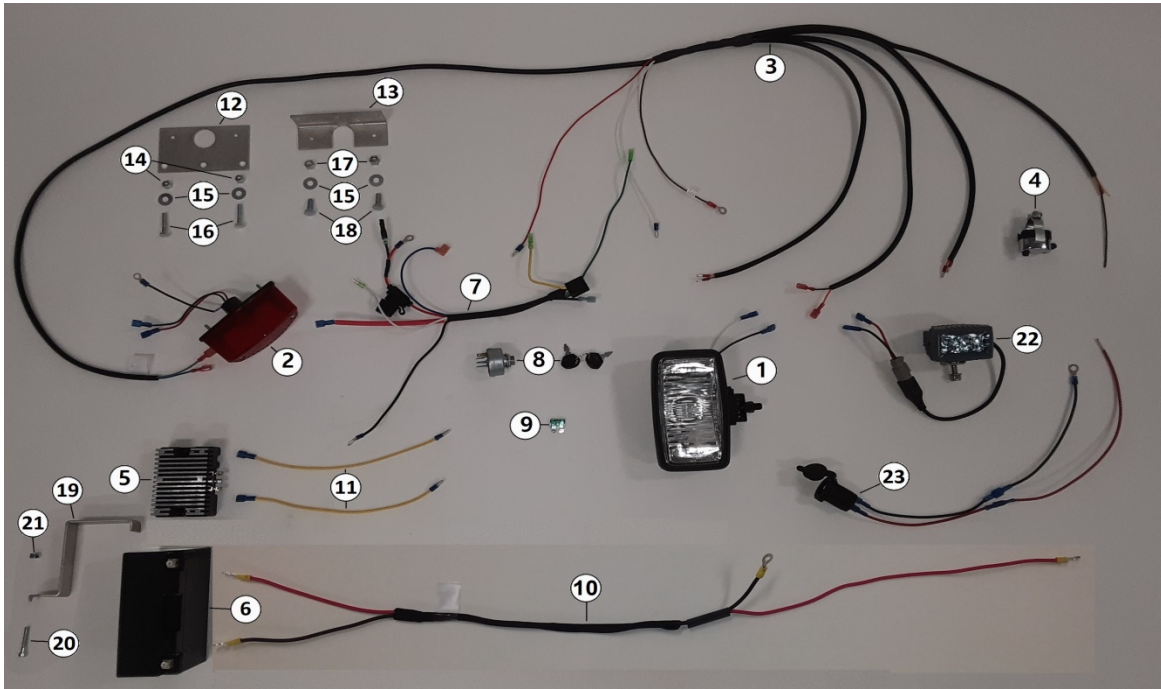

ITEM	PART NUMBER	DESCRIPTION	QTY
1	104313	Head Light	1
2	104315	Tail Light	1
3	108179	Wiring Harness 7HP	1
4	100191	Kill Button & Headlight On/Off	1
5	108126	Voltage Regulator	1
6	MK7BBS	Battery AGM	1
7	KOH1717618-S	7HP Engine Harness	1
8	KOH2509937-S	Ignition Switch (Includes Keys)	1
9	KOH 33-034	Fuse, 25 Amp	1
10	104323	Battery Harness	1
11	120024	Lead, Voltage regulator	2
12	101135	Tail Light Bracket	1
13	101136	Tail Light Bracket, Cargo Rack	1
14	100169	Lock Nut, ¼ - 28	2
15	100255	Washer	2
16	100170A	Bolt, ¼ - 28 x 1 ½"	2
17	100551	Lock Nut, 5/16 - 24	2
18	100848	Bolt, 5/16 - 24 x ¾"	2
19	108274	Battery Hold-Down	1
20	108963	Bolt, 10 - 32 x 1 ¼"	1
21	100037	Lock Nut, 10 - 32	1
22	108920	LED Headlight (Optional)	
23	109009	Power Point (Optional)	

17-4 STREET LEGAL COMPONENTS (RANGER ONLY)

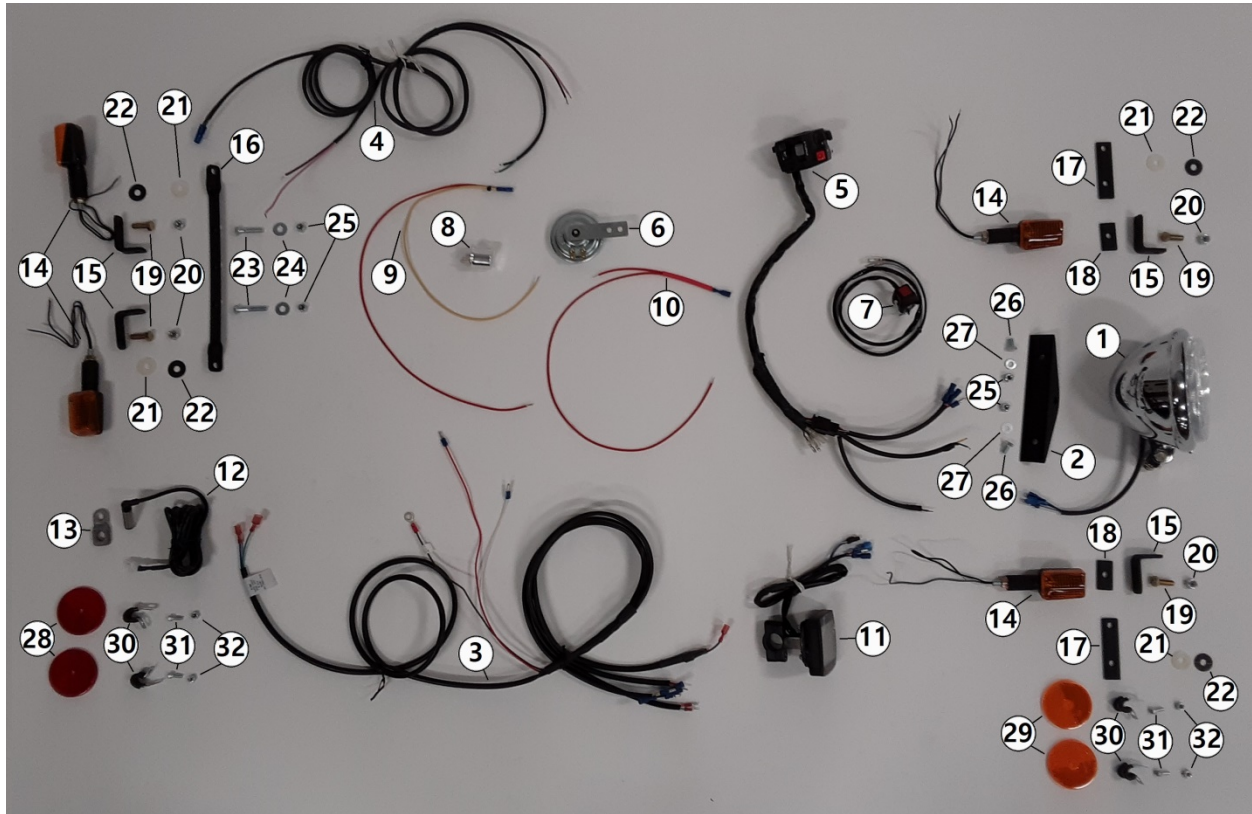

ITEM	PART NUMBER	DESCRIPTION	QTY
1	104314	Head Light, Hi/Lo	1
2	104317	Bracket, Hi/Lo Head Light	1
3	104318	Wiring Harness, 7HP Ranger	1
4	104319	Turn Signal Harness, Ranger	1
5	KS12-0050	Street Legal Multifunction Switch	1
6	108971	Horn	1
7	EM46-50430	Kill Button, Right Side	1
8	FLA552	Flasher Unit	1
9	104320	Harness, Flasher	1
10	104321	Harness, Speedometer/Horn	1

**Continued*

17-4 (Continued)

ITEM	PART NUMBER	DESCRIPTION	QTY
11	103191	Speedometer/Odometer	1
12	103193	Speedometer/Odometer Sensor	1
13	103194	Speedometer Sensor Bracket	1
14	108942	Turn Signal Light (set of 2)	2
15	103195	Turn Signal Mount	4
16	103196	Rear Turn Signal Bracket	1
17	103197	Front Turn Signal Bracket, Lower	2
18	103198	Front Turn Signal Bracket, Upper	2
19	100038	Bolt, 5/16-18	4
20	100171	Lock Nut, 5/16-18	4
21	103199	Washer, Nylon	4
22	103200	Washer, Spring	4
23	100170	Bolt, ¼-28 x 1 ½	2
24	100255	Washer, Flat	2
25	100169	Lock Nut, ¼-28	4
26	100167	Bolt, ¼-28 x ½	2
27	100165	Washer, Flat	2
28	108975	Reflector, Red (set of 2)	1
29	108976	Reflector, Amber (set of 2)	1
30	FAS SPN CLAMP 11/16	Reflector Mounting Clamp	4
31	108964	Cap Screw, 10-32 x ½	4
32	100037	Lock Nut, 10-32	4

17-5 ENGINE AND COMPONENTS

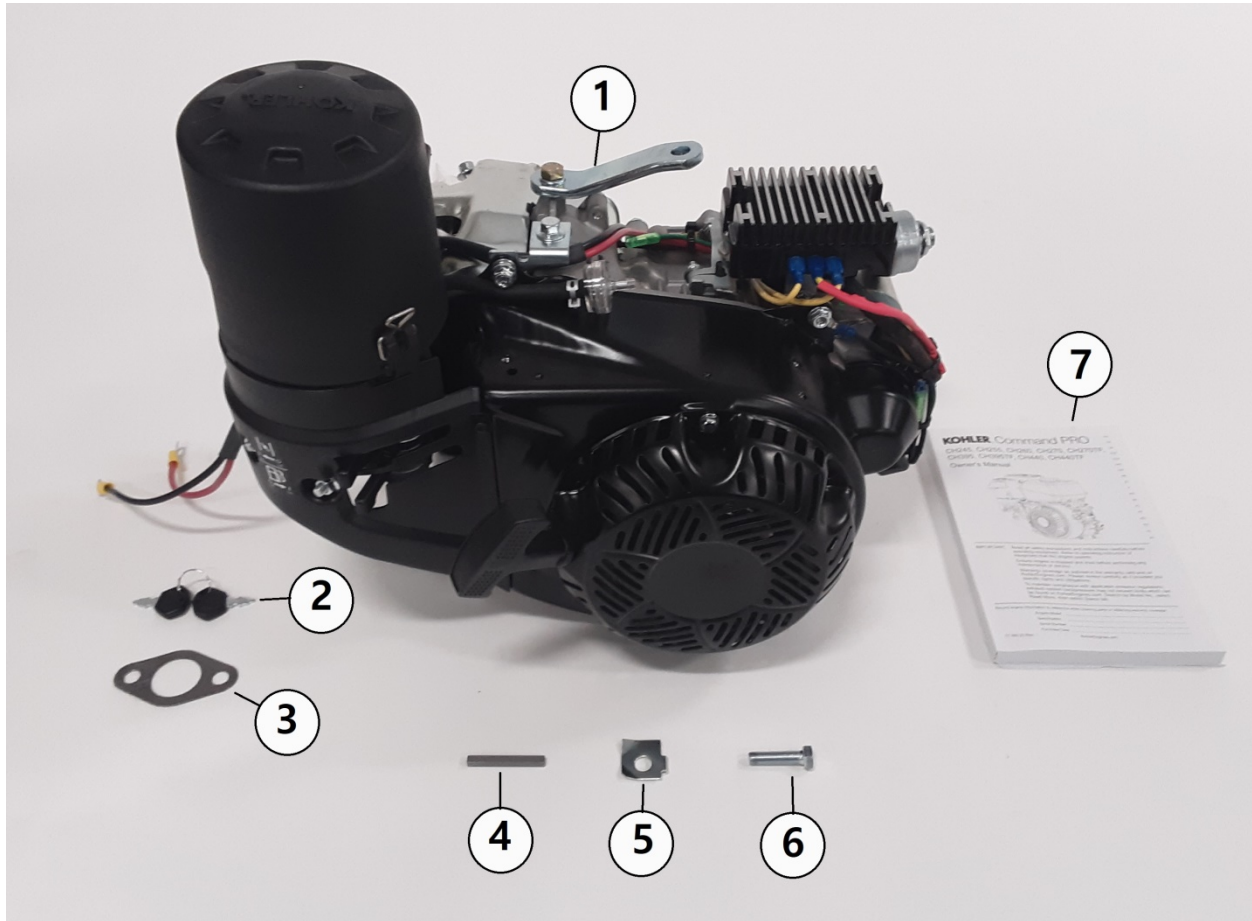

ITEM	PART NUMBER	DESCRIPTION	QTY
1	KOHCH270	7HP Engine Complete	1
2	KOH4834001-S1	Ignition Key (sold individually)	2
3	KOH1704103-S	Exhaust Gasket	1
4	KOH1434001-S	Key, Crank, 7HP	1
5	108983	Locking Clip	1
6	108123	Clutch Bolt	1
7	KOH7HPMAN	7HP Engine Manual	1

**Continued*

17-5 (Continued)

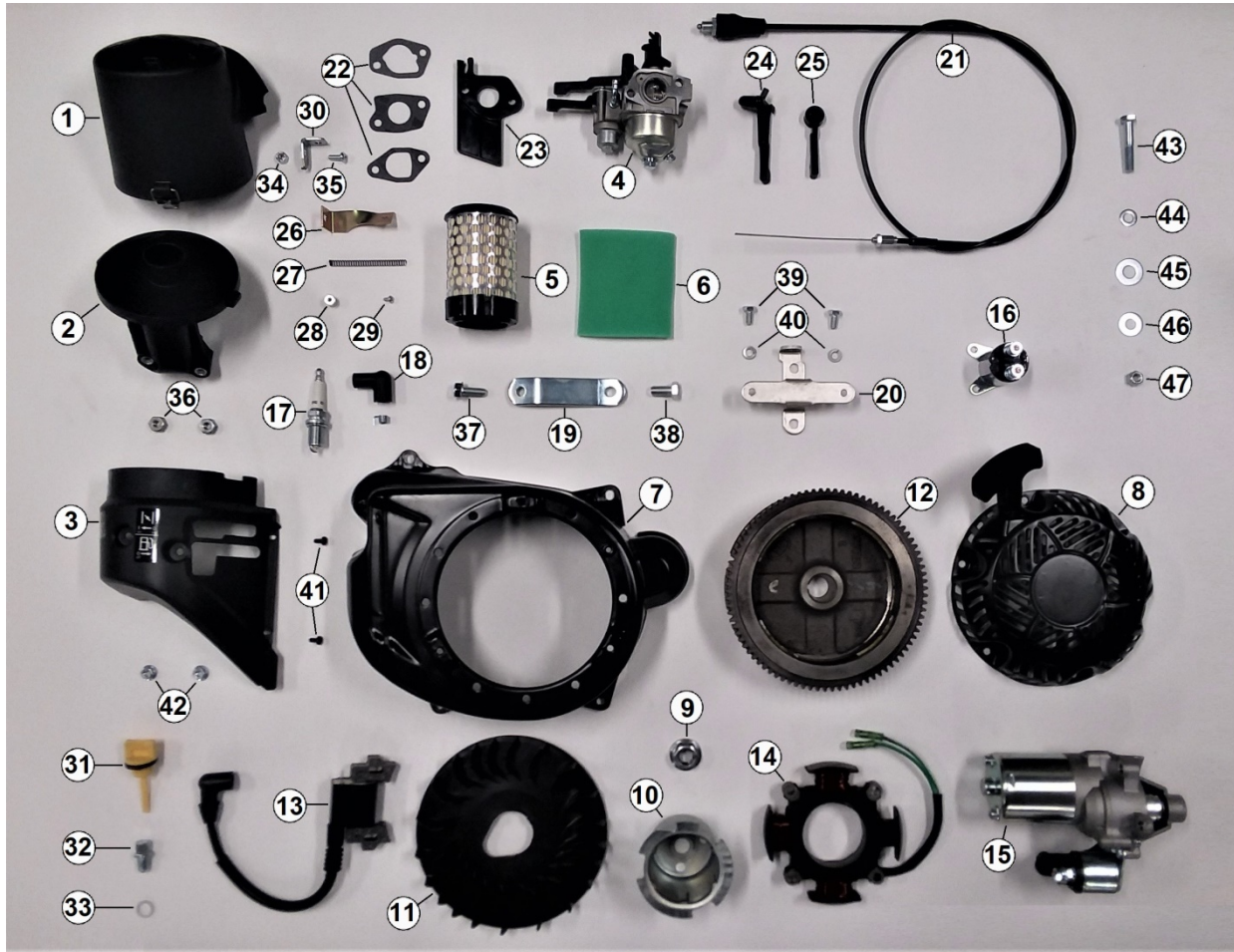

ITEM	PART NUMBER	DESCRIPTION	QTY
1	KOH1709641-S	Air Filter Cover	1
2	KOH1709423-S	Air Filter Base	1
3	KOH1709604-S	Carburetor Cover	1
4	KOH1785322-S	Carburetor 7HP	1
5	KOH1708307-S	Air Filter	1
6	KOH1708312-S	Air Pre-Cleaner	1
7	KOH1702710-S	Blower Housing 7HP	1
8	KOH1716502-S	7HP Recoil Assembly	1
9	KOH1710048-S	Flywheel Nut	1
10	KOH1710901-S	Starter Cup 7HP	1
11	KOH1715706-S	Cooling Fan 7HP	1
12	KOH1702530-S	Flywheel 7HP	1
13	KOH1758401-S	Ignition Module 7HP	1
14	KOH1708507-S	Stator 7HP	1

**Continued*

17-5 (Continued)

ITEM	PART NUMBER	DESCRIPTION	QTY
15	KOH1709810-S	Electric Starter 7HP (Includes Solenoid)	1
16	KOH1743506-S	Starter Solenoid	1
17	100369K7	Spark Plug 7HP	1
18	K-705-2	Sparky	1
19	109000	Head Steady, Kohler	1
20	110043	7HP Voltage Regulator Bracket	1
21	107037	Throttle Cable 7HP	1
22	KOH1704103-S	Intake Gasket Kit (3pcs)	1
23	KOH1716805-S	Carburetor Insulator	1
24	KOH1709005-S	Choke Lever	1
25	KOH1709004-S	Fuel Shut-off Lever	1
26	110054	Throttle Bracket	1
27	100559	Throttle Spring	1
28	110058	Cable Holder 7HP	1
29	100459	Screw, PH 6/32 x ¼	1
30	108246	Air Filter Cover Retaining Tab	1
31	KOH1703808-S	Dipstick 7HP	2
32	KOH1713901-S	Oil Drain Plug 7HP	2
33	KOH1703230-S	Drain Plug Oil Seal	2
34	100037	Lock Nut, 10-32	1
35	100034	Screw, PH	1
36	KOH1710043-S	Intake Housing Nut	2
37	108943	Bolt, Head steady	1
38	100572	Bolt, 3/8-24	1
39	100167	Bolt, ¼-28 x ½	2
40	100281	Washer, ¼ Lock	2
41	KOH25086217-S	Torx Screw, Carb Cover	2
42	KOH1410009-S	Nut, Carb Cover	2
43	108967	Bolt, 8-1.25	4
44	108965	Washer, Flat 8mm	4
45	100208	Washer, Flat 3/8	8
46	100202	Washer, Flat 5/16	4
47	108966	Lock Nut, 8-1.25	4
NS	KOH1437901-S	Pawl Repair Kit	
NS	KOH1475514-S	Kit, High Altitude, 4-8K	
NS	KOH1475523-S	Kit, High Altitude, 8K+	

NOTICE: To purchase internal engine components you must contact ROKON International

17-6 FRAME AND COMPONENTS

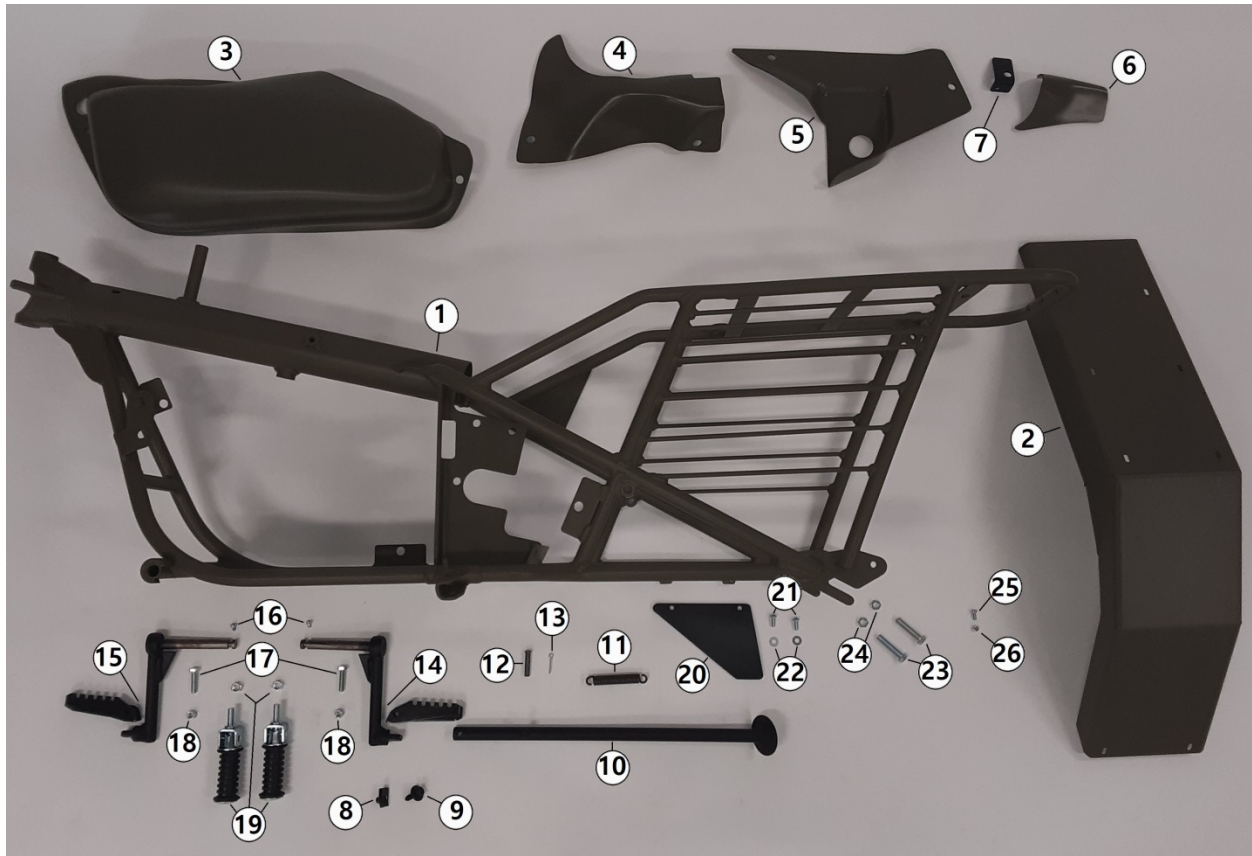

ITEM	PART NUMBER	DESCRIPTION	QTY
1	105066	Frame Assembly Kohler 7HP	1
2	110049	Rear Fender Kohler 7HP	1
3	108994	Fairing, LHS	1
4	108995	Fairing, RHS Front	1
5	108996B	Fairing, RHS Bottom	1
6	108996T	Fairing, RHS Top	1
7	108927	RHS Top Fairing Mounting Tab	1
8	101630	Receptacle Nut, Fairing	7
9	101629	Mounting Bolt, Fairing	7

**Continued*

17-6 (Continued)

ITEM	PART NUMBER	DESCRIPTION	QTY
10	100386	Kickstand	1
11	100223	Kickstand Spring	1
12	100285	Clevis Pin, 5/16 x 1 3/8	1
13	100290	Cotter Pin, 1/8 x 3/4	1
14	108144A	Foot Rest RHS Cleated	1
15	108146A	Foot Rest LHS Cleated	1
16	108962	Screw, 10-32 x 1/4	2
17	108123	Bolt, 5/16 – 24 x 1 ½	2
18	100551	Lock Nut, 5/16 – 24	2
19	100343	Passenger Foot Rest Assembly (set of 2)	1
20	101572	Rear Chain Guard	1
21	100126	Screw PH, ¼ - 20 x 5/8	2
22	100165	Washer, Flat	2
23	100573	Wheel Adjuster Bolt, 3/8 – 24 x 1 ¾	2
24	100036	Nut, 3/8 – 24 Jam	2
25	100034	Fender Mounting Screw, PH 10 – 32 x 1/2	6
26	100037	Fender mounting Lock Nut, 10- 32	6

17-7 STANDARD FRONT FORK (SCOUT)

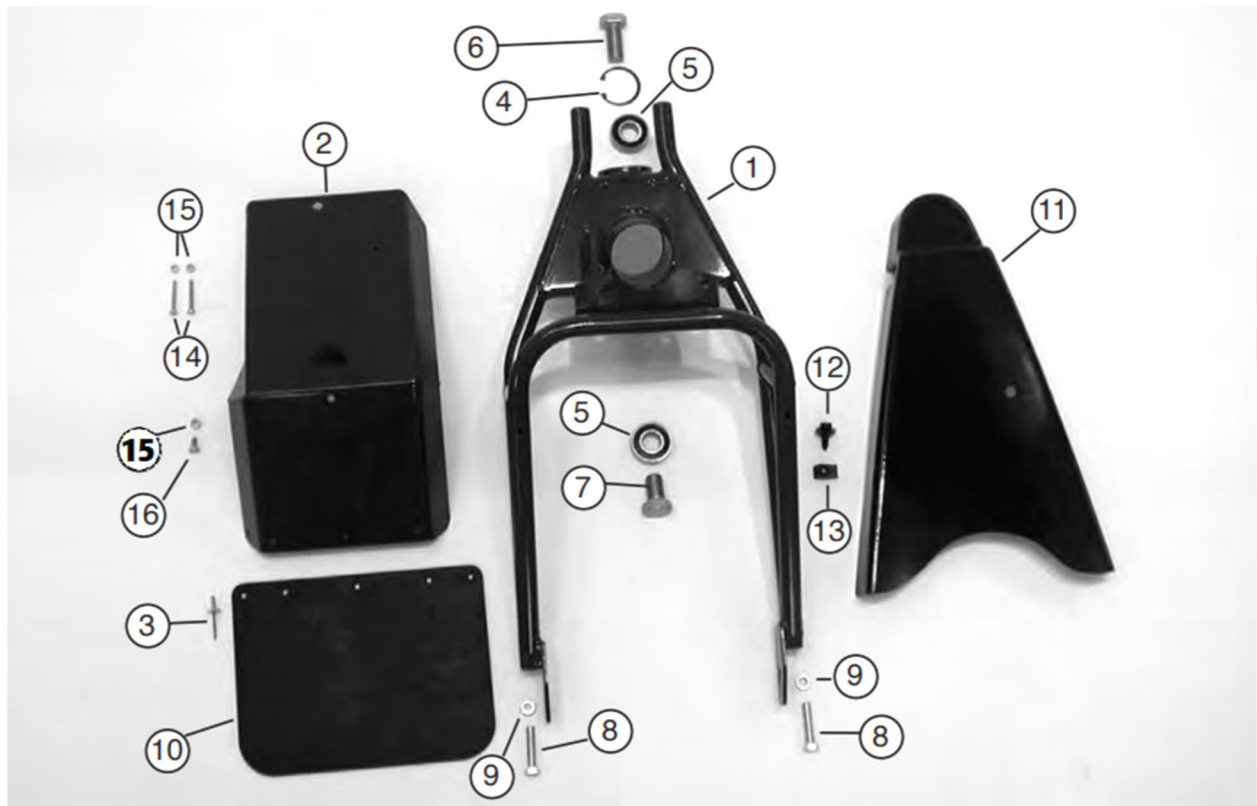

ITEM	PART NUMBER	DESCRIPTION	QTY
1	107003A	Front Fork	1
2	100453	Front Fender	1
3	100935	Pop Rivet	5
4	103136	Snap Ring	1
5	100772	Bearing	2
6	107026	Upper Fork Bolt	1
7	107025	Lower Fork Bolt	1
8	100573	Wheel Adjuster Bolt 3/8-24 x 1 3/4	2
9	100036	Hex Nut Jam 3/8-24	2
10	100427	Front Mud Flap	1
11	108106	Front Chain Guard	1
12	101629	Mounting Bolt, Fairing	1
13	101630	Receptacle Nut, Fairing	1
14	108963	Screw, 10-32 x 1 1/4	2
15	100037	Lock Nut, 10-32	3
16	100034	Screw, 10-32 x 1/2	1

17-8 AUTOGRAB FRONT FORK (TRAIL-BREAKER AND RANGER)

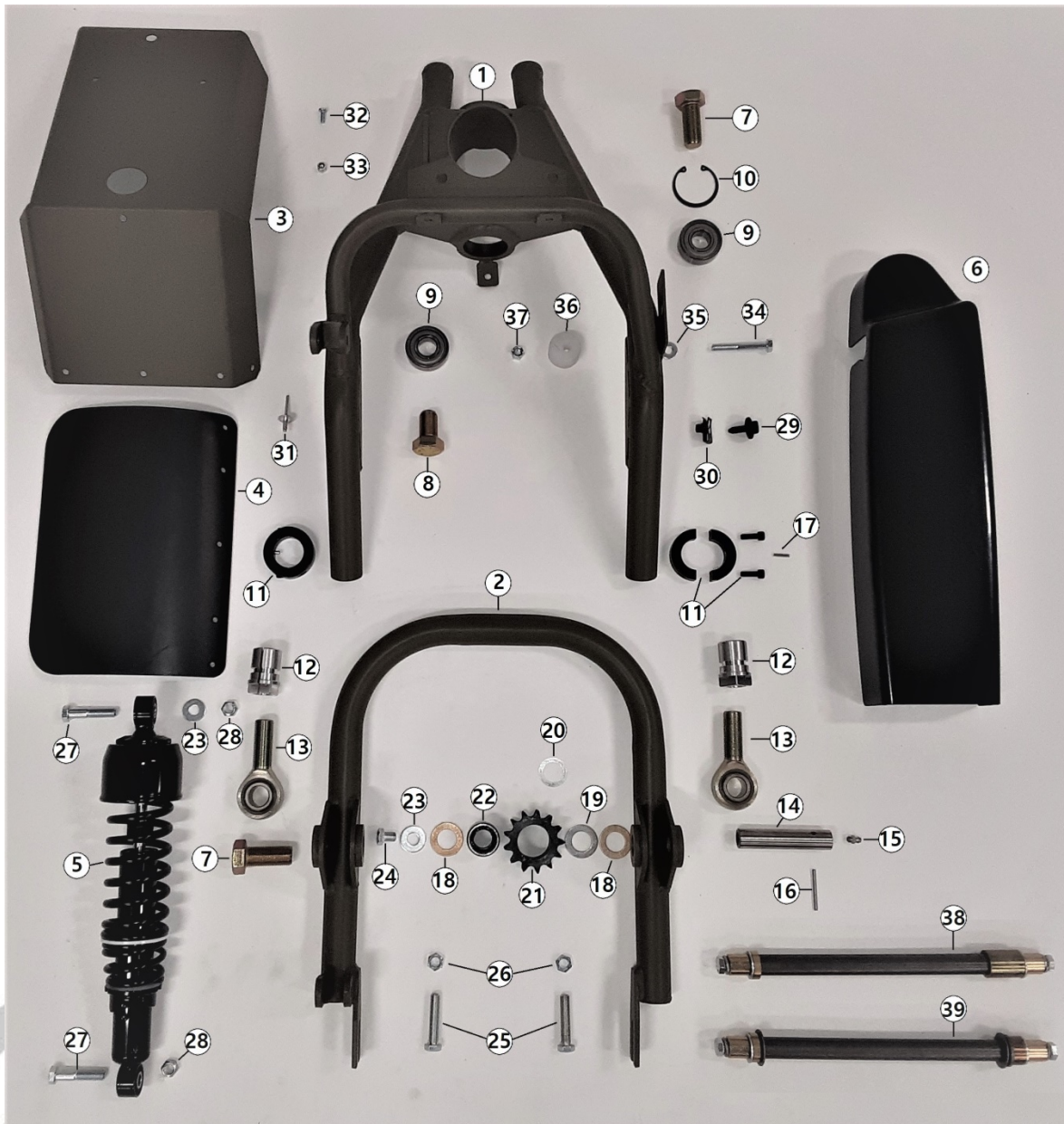

ITEM	PART NUMBER	DESCRIPTION	QTY
1	108303	Fork, Front Suspension	1
2	108311	Swing Arm Tube	1
3	100453	Front Fender	1
4	100427	Front Mud Flap	1
5	109002-S2	Shock absorber	1
6	108299	Front Chain Guard, Suspension	1
7	107026	Upper Fork/Swing Arm Bolt	2
8	107025	Lower Fork Bolt	1

17-8 (Continued)

ITEM	PART NUMBER	DESCRIPTION	QTY
9	100772	Bearing	2
10	103136	Snap Ring	1
11	108320	Collar Clamp Assembly	2
12	108319	Adjuster Nut, Rod End	2
13	108335	Spherical Rod End	2
14	108309	Idler Shaft	1
15	108327	Grease Fitting	1
16	108322	Dowel Pin, 1/8 x 1 1/2	1
17	108321	Roll Pin, 1/8 x 1/2	2
18	108336	Thrust Bearing	2
19	300090C	Spacer	1
20	101615	Shim, 3/4 ID x .005	AS NEEDED
21	108308	Double Sprocket	1
22	108323	Needle Bearing	1
23	100202	Washer, Flat	2
24	108326	Bolt, 3/8 – 24 x 1/2	1
25	100573	Wheel Adjuster Bolt 3/8-24 x 1 3/4	2
26	100036	Hex Nut Jam 3/8-24	2
27	101181	Bolt, 3/8 – 24 x 1 3/4	2
28	100212	Lock Nut, 3/8 – 24	2
29	101629	Mounting Bolt, Fairing	1
30	101630	Receptacle Nut, Fairing	1
31	100935	Pop Rivet	5
32	100034	Screw, 10-32 x 1/2	3
33	100037	Lock Nut, 10-32	3
34	101529	Bolt, 5/16 – 18	1
35	100255	Washer, Flat	2
36	110059	Chain Guide Roller	1
37	100171	Lock Nut, 5/16 – 18	1
38	108932	Axle Kit, Suspension, Drum Wheel	
39	108931	Axle Kit, Suspension, Spoke Wheel	

17-9 FRONT CARGO RACK

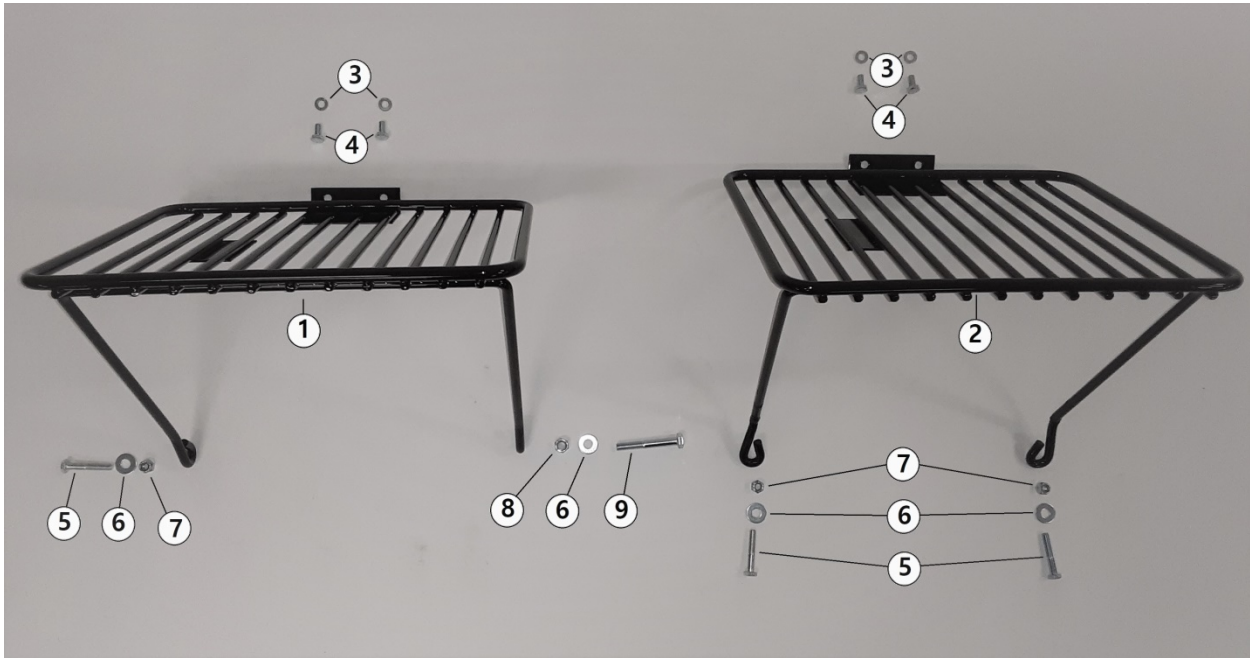

ITEM	PART NUMBER	DESCRIPTION	QTY
1	110015	Front Cargo Rack (Trail-Breaker & Ranger)	0-1
2	100423	Front Cargo Rack (Scout)	0-1
3	100281	Washer, ¼ Lock	2
4	100167	Bolt, ¼-28 x ½	2
5	100170	Bolt, ¼-28 x 1 ½	1 - 2
6	100255	Washer, Flat	2
7	100169	Lock Nut, ¼-28	2
8	100171	Lock Nut, 5/16 - 18 (Autograb ONLY)	1
9	101529	Bolt, 5/16 - 18 (Autograb ONLY)	1

17-10 FUEL TANK



ITEM	PART NUMBER	DESCRIPTION	QTY
1	103120B	Fuel Tank Assembly, Steel (TC)	1
2	102851	Fuel Cap, Steel Tank, Ratchet Cap	1
3	100122	Fuel Line Set (set of 2)	1
4	102766	Fuel Filter	1
5	101969	Rubber Fuel Tank Washer	1
6	102589	Flat Washer	1
7	101971	Bolt, ½-20 x 1 ½	1
8	101295	Fuel Tank Shut-Off Valve	1
9	102590	Fuel Tank Fitting	1
10	102594	O-Ring Fuel Tank	1
11	102593	Nut, 9/16-18	1

17-11 EXHAUST SYSTEM

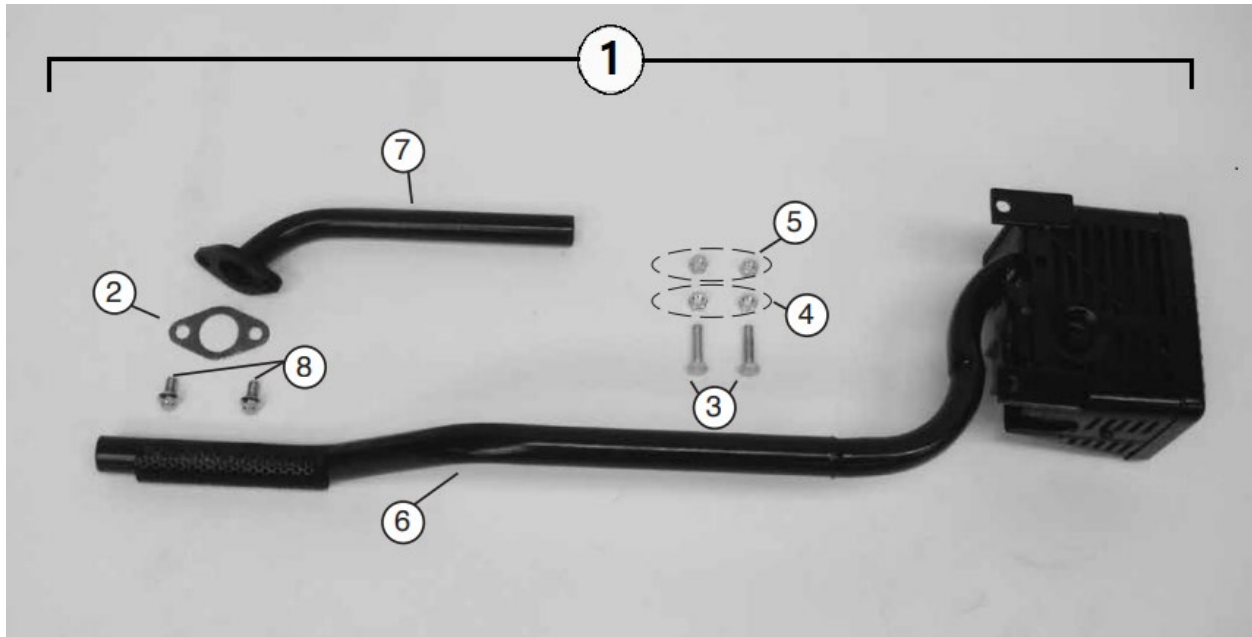

ITEM	PART NUMBER	DESCRIPTION	QTY
1	108237	Exhaust Assembly 7HP (Complete)	1
2	KOH1704109-S	Gasket, Muffler 7HP	1
3	108123	Bolt, 5/16-24 x 1 ¼	2
4	100211	Nut, 5/16 – 24	2
5	100551	Lock Nut, 5/16 – 24	2
6	108239A	Exhaust, Muffler section	1
7	108239B	Exhaust, Head Pipe	1
8	KOH25086224-S	Head Pipe Bolt	2

17-12 HANDLEBARS AND BRAKES

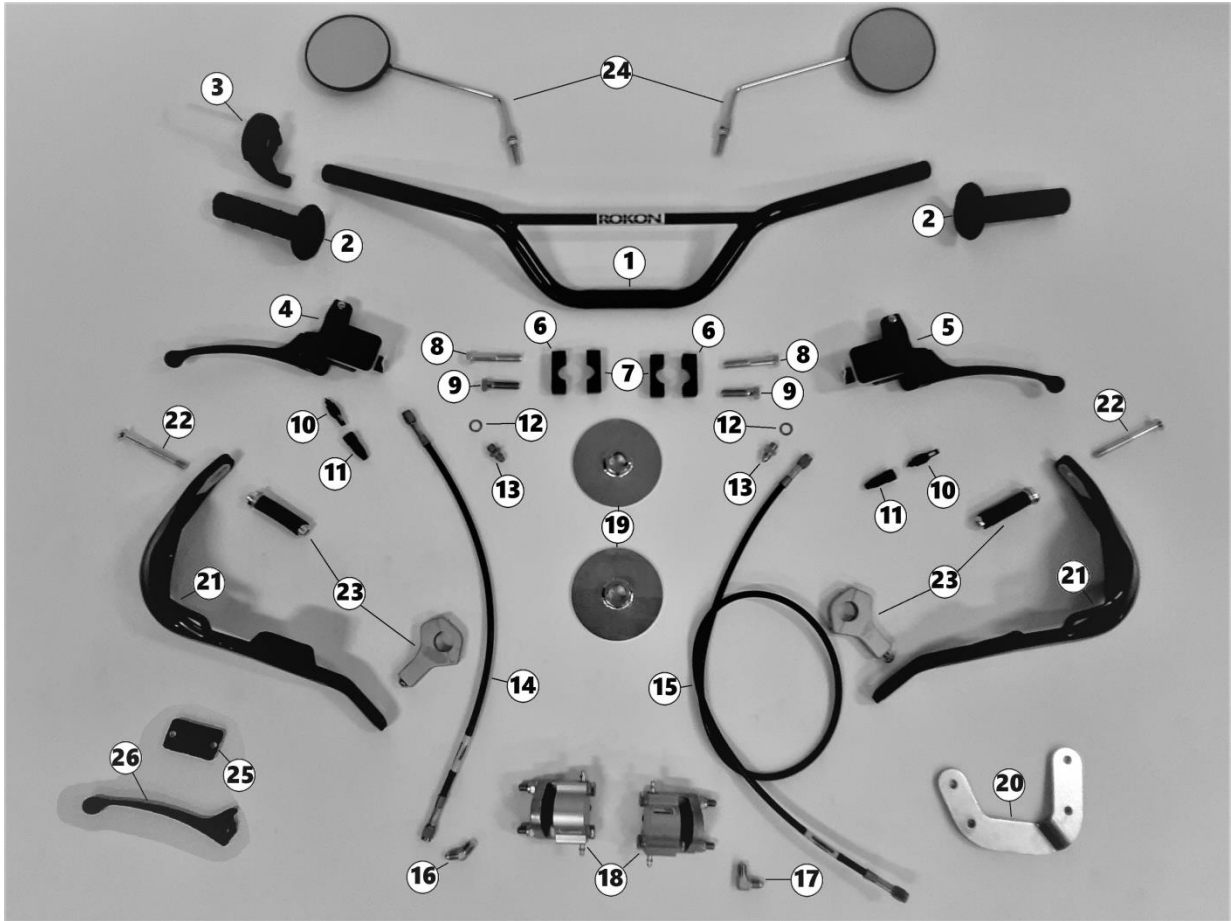

ITEM	PART NUMBER	DESCRIPTION	QTY
1	100466	Handlebar	1
2	100071	Grip Set (Includes both grips)	1
3	103113	Throttle Twist Grip	1
4	108958	Front Brake Master Cylinder (Right)	1
5	108957	Rear Brake Master Cylinder (Left)	1
6	108115	Handle Bar Clamp, Upper	2
7	108116	Handle Bar Clamp, Lower	2
8	108986	Bolt, 3/8 – 24 x 2 ¼	2

**Continued*

17-12 (Continued)

ITEM	PART NUMBER	DESCRIPTION	QTY
9	108985	Bolt, 3/8 – 24 x 1 ½	2
10	104309	Brake Light Switch	2
11	107033	Brake Light Switch Dust Boot	2
12	GR44516	Master Cylinder Sealing Washer (copper)	2
13	GR306-03-31SZ1	Brake Hose Adapter Fitting (straight)	2
14	108960	Front Brake Hose	1
15	108961	Rear Brake Hose	1
16	GR823-03102	Brake Hose Adapter Fitting (45deg)	1
17	GR822-03DE	Brake Hose Adapter Fitting (90deg)	1
18	108013	Brake Caliper Hydraulic	2
19	100610	Brake Disc	2
20	110032	Rear Brake Caliper Bracket 7HP	1
21	109019	Brush Busters (Complete, Optional)	1
22	108997	Brush Buster end bolt	
23	109019H	Brush Buster Hardware Kit	
24	MIRROR	Mirror, Set of 2 (Optional)	1
25	0413380	Brake Reservoir Diaphragm (Universal L/R)	2
26	100823	Brake Lever (Universal L/R)	2

17-13 BRAKE CALIPER

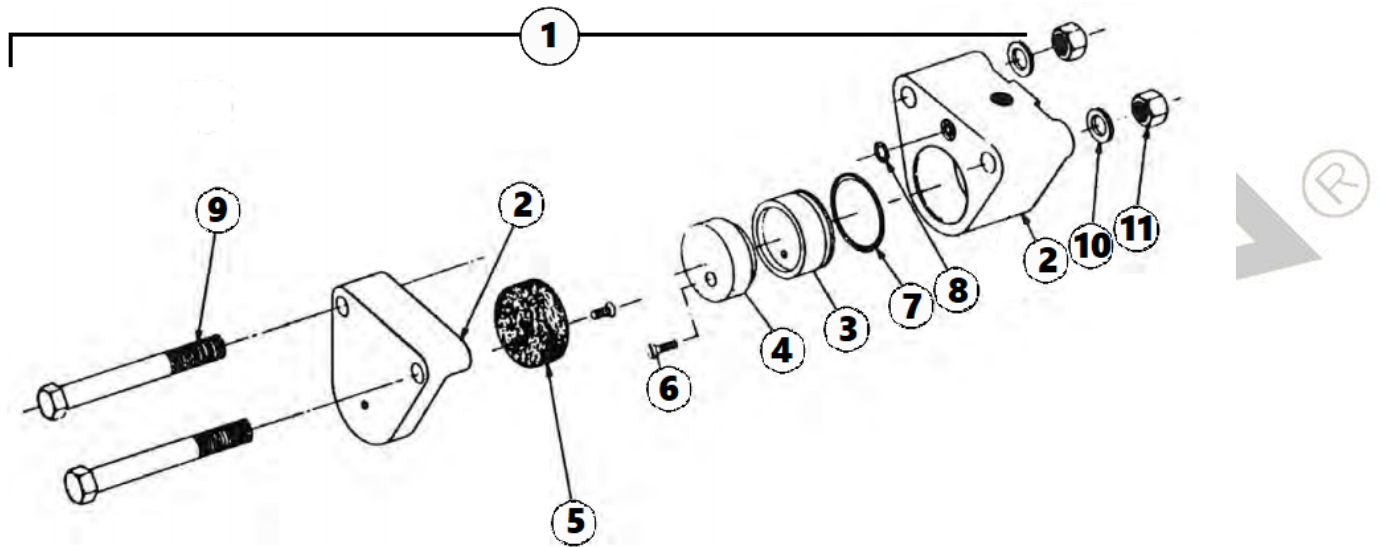

ITEM	PART NUMBER	DESCRIPTION	QTY
1	108013	Brake Caliper Assembly	2
2	0708-1001	Caliper Housing	2
3	0701-1062	Piston	2
4	108033	Brake Puck Live Side	2
5	108030	Brake Puck Dead Side	2
6	0701-1006	Screw, Brake Puck Retainer	2
7	0701-1004	O-Ring, Piston	2
8	0701-1003	O-Ring, Buna-N	2
9	3030-1007	Housing Bolt	4
10	0701-1007	Washer	4
11	0701-1008	Lock Nut	4
12	100481	Brake Puck Set (Includes 4 and 5)	

17-14 OPERATOR SEAT

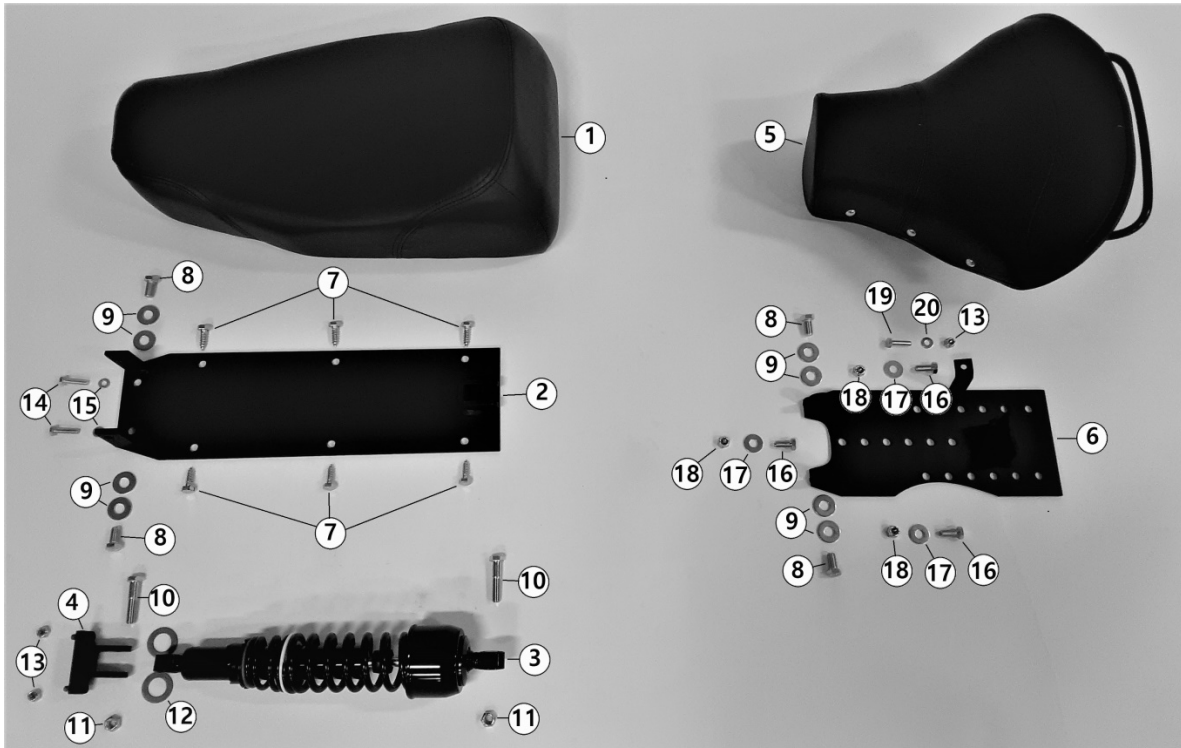

ITEM	PART NUMBER	DESCRIPTION	QTY
1	100452	Front Seat, Saddle Style	1
2	108063	Seat Base Plate	1
3	109002-S2	Seat Shock Absorber	1
4	108062	Lower Shock Mount	1
5	100136	Front Seat, Retro (optional)	1
6	110067	Retro Seat Base Plate (optional)	1
7	101629S	Lag Bolt	6
8	100572	3/8 – 24 x 5/8	2
9	100208	Washer, 1/2 Flat	4
10	101181	Bolt, 3/8 – 24 x 1 3/4	2
11	100212	Lock Nut, 3/8 – 24	2
12	300090C	Washer, Flat	2
13	100169	Lock Nut, 1/4 - 28	1-2
14	100277	Bolt, 1/4 - 20 x 1	2
15	100281	Lock Washer, 1/4	2
16	100848	Bolt, 5/16 – 24	3
17	100202	Washer, 3/8 Flat	3
18	100551	Lock Nut, 5/16 – 24	3
19	100166	Bolt, 1/4 - 28 x 1	1
20	100255	Washer, Flat	1-4
NS	100452-Camo	Front Seat, Camouflage (Optional)	

17-15 PASSENGER SEAT

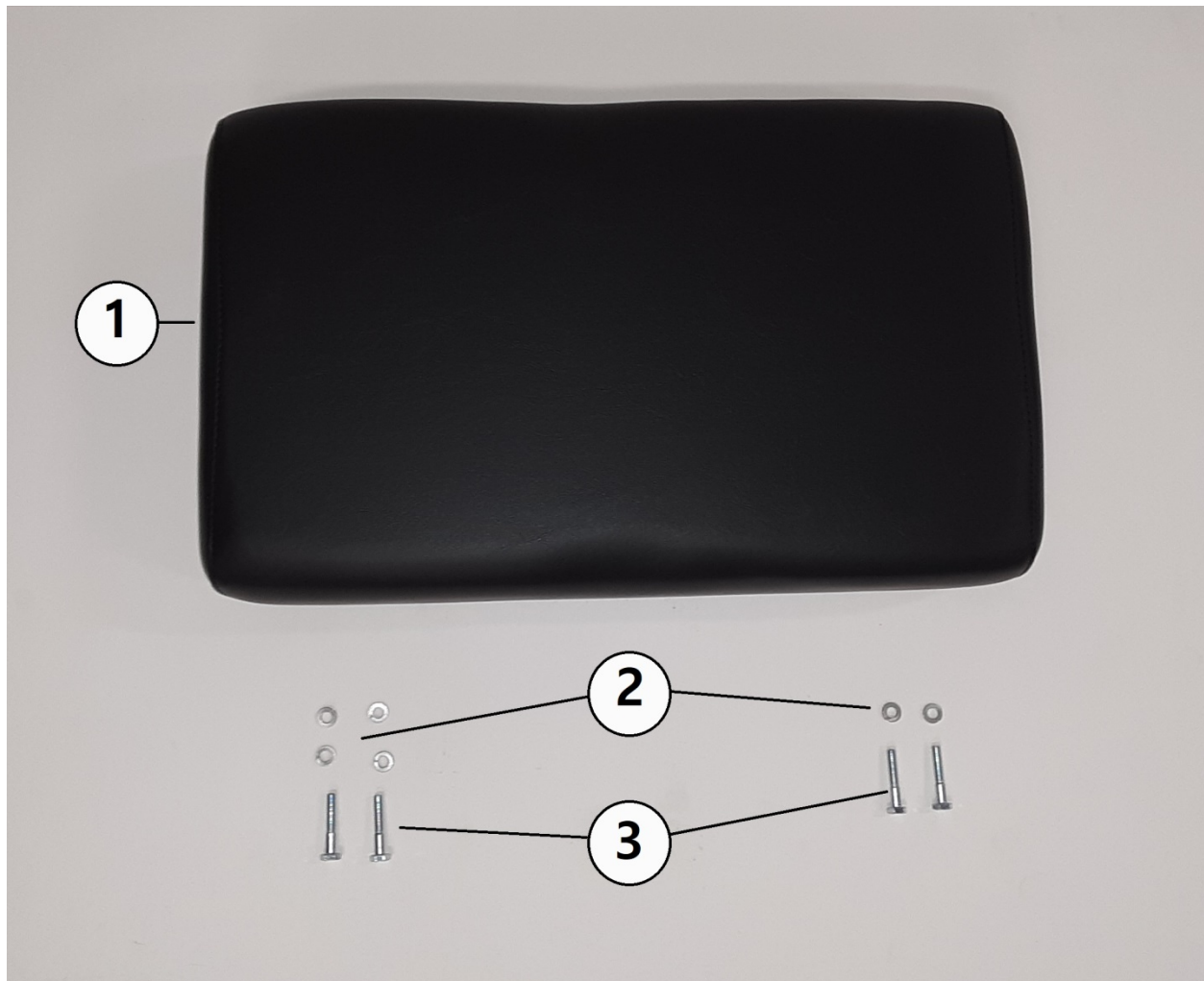

ITEM	PART NUMBER	DESCRIPTION	QTY
1	100340	Rear Seat	1
2	100281	Lock Washer, 1/4	6
3	105037	Bolt, 1/4 - 20 x 1 3/8	4
NS	100340-C	Rear Seat, Camouflage (Optional)	

17-16 CVT DRIVE PULLEY (CLUTCH)

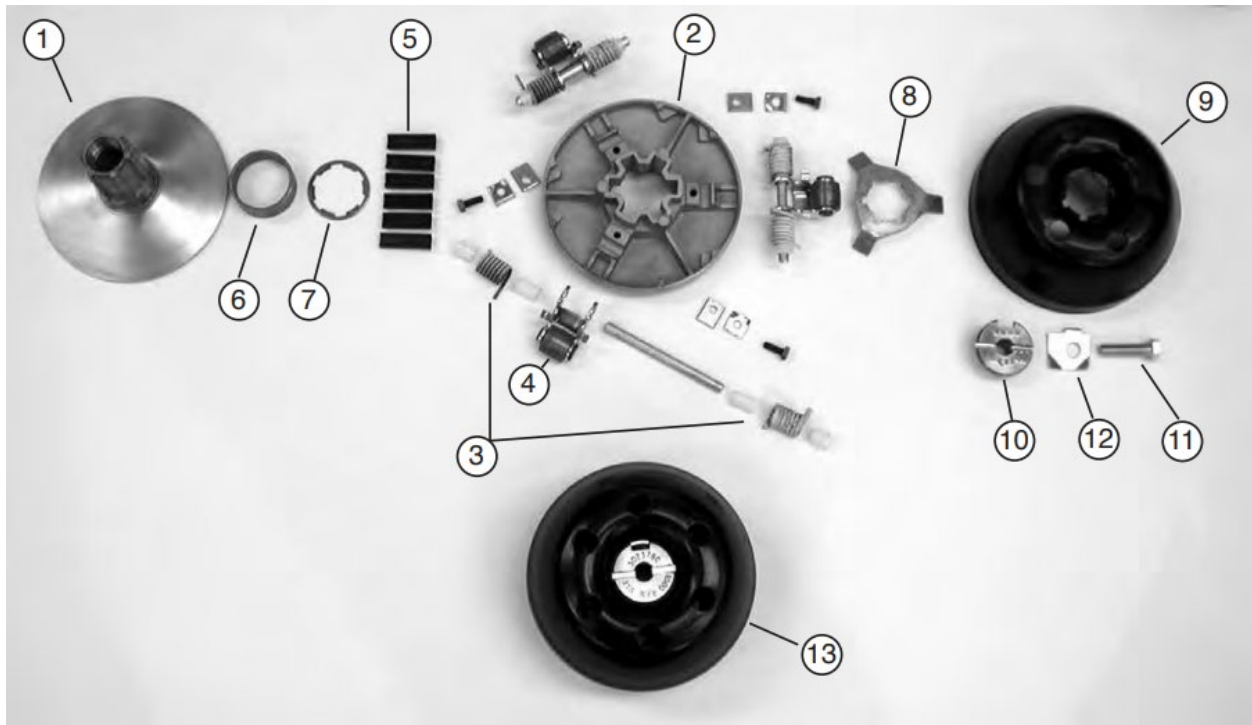

ITEM	PART NUMBER	DESCRIPTION	QTY
1	703209	Fixed Face, Drive Pulley	1
2	601319	Movable Face, Drive Pulley	1
3	690144K	Pivot Pin Kit (Includes Pins and Bushings)	1
4	690146K	Roller Kit (Includes Rollers and Arms)	1
5	703128	Liner Spline	6
6	703116	Bearing, Idler	1
7	703127	Spline Washer	1
8	703129	Retractor Plate	1
9	703151	Ramp Plate	1
10	703211	Ramp Plate Retaining Bolt	1
11	108123	Clutch Mounting Bolt	1
12	108983	Locking Clip	1
13	100885	CVT Drive Pulley (Complete)	1
NS	HOF302221A	Spring Kit (Includes all 6 springs)	1

17-17 CVT DRIVEN PULLEY

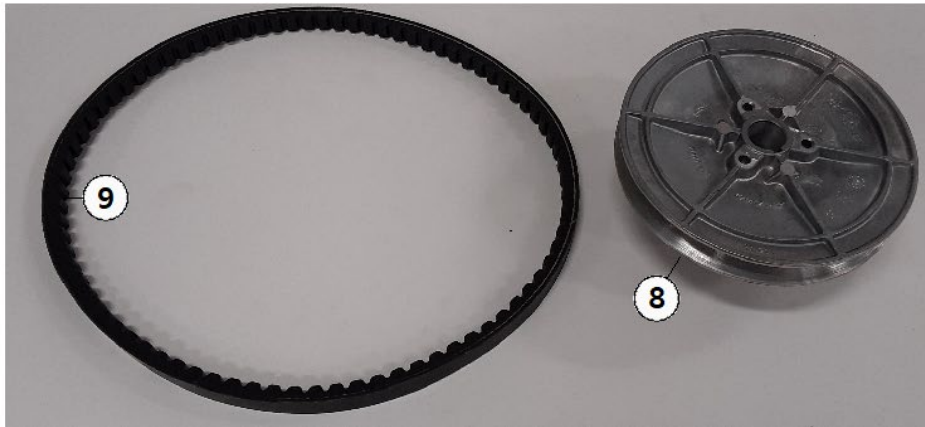
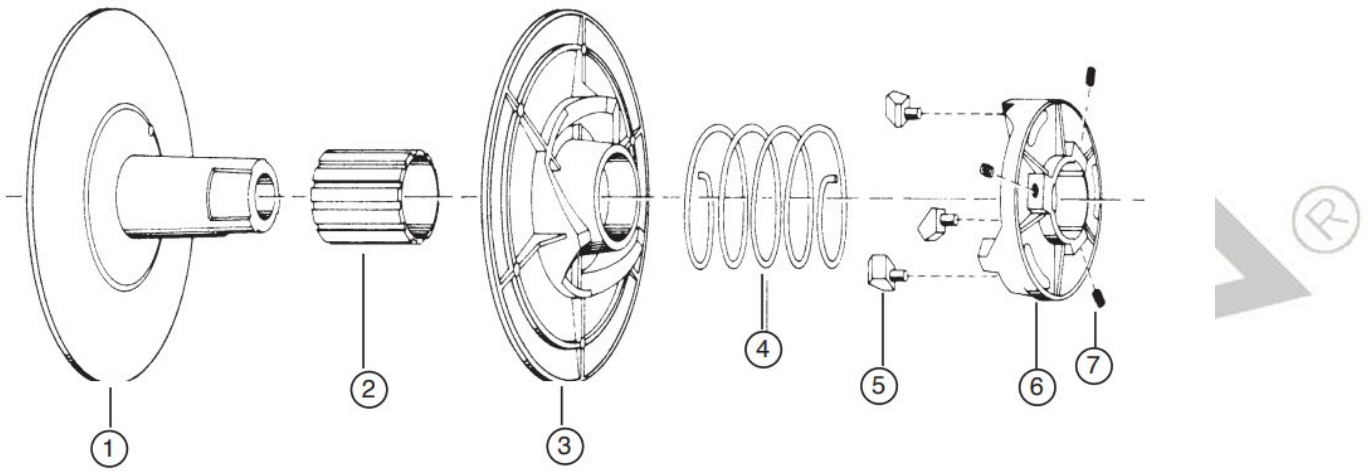

ITEM	PART NUMBER	DESCRIPTION	QTY
1	601311	Hub, Fixed Face, Driven Pulley	1
2	703110	Bearing	1
3	703109	Movable Face, Driven Pulley	1
4	703111	Spring	1
5	703305	Button Shoe Ramp	3
6	601406	Torque Bracket	1
7	901709	Set Screw, ¼ - 20 x 3/8	3
8	100884	CVT Driven Pulley (Complete)	1
9	108137	CVT Drive Belt	1

17-18 TRANSMISSION EXTERNAL

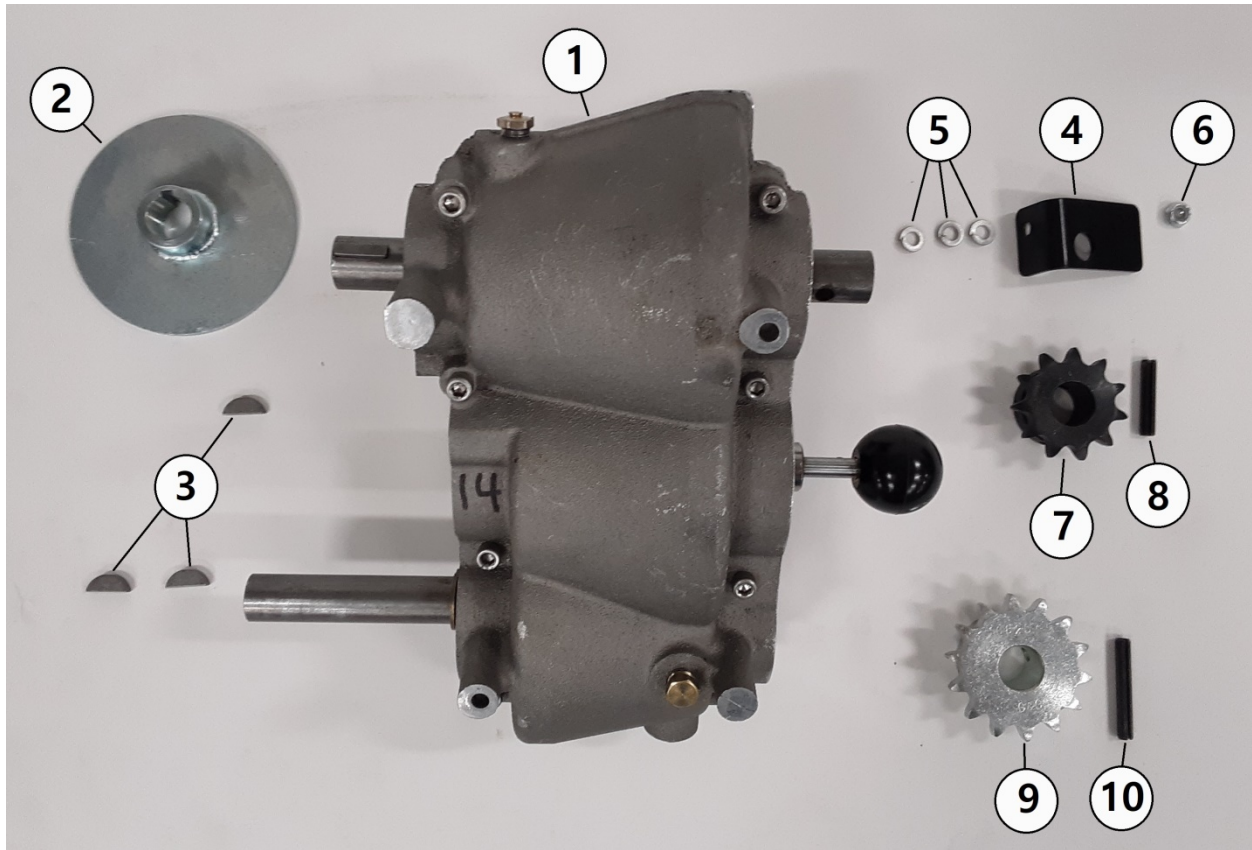

ITEM	PART NUMBER	DESCRIPTION	QTY
1	103140	Transmission Assembly	1
2	100610	Brake Disc	1
3	100043	Woodruff Key, #9	3
4	108927	RHS Top Fairing Mounting Tab	1
5	100281	Lock Washer, 1/4	3
6	108997	Lock Nut, 1/4 - 20	1
7	100040	Sprocket, 11 tooth	1
8	100270	Roll Pin, 1/4 x 1 3/8	1
9	108257	Sprocket, 14 tooth (Ranger Only)	1
10	100272	Roll Pin, 1/4 x 1 3/8 (Ranger Only)	1

17-19 TRANSMISSION INTERNAL

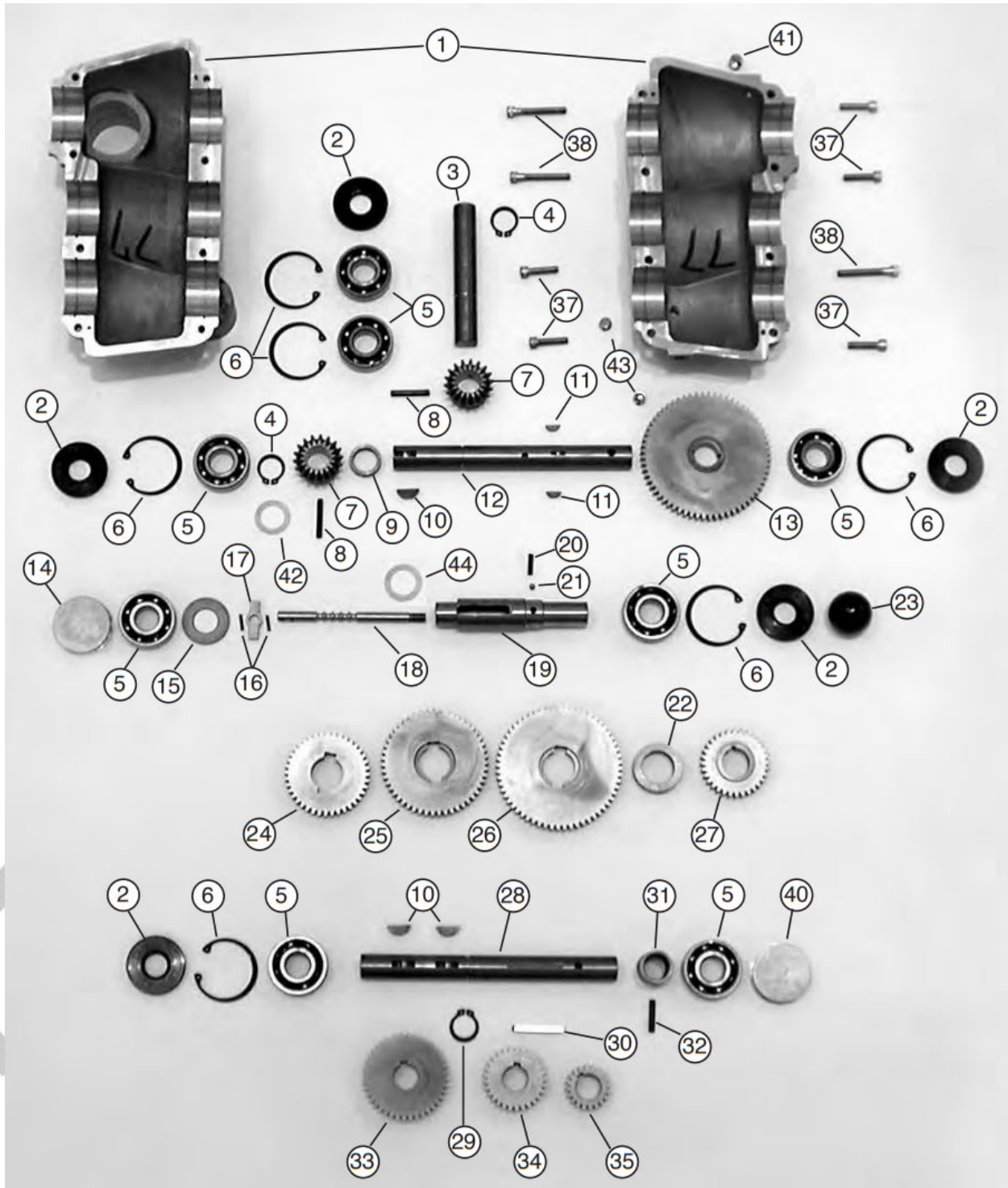

**Continued*

17-19 (Continued)

ITEM	PART NUMBER	DESCRIPTION	QTY
1	103141	Transmission Casting Machined (2 halves)	1
2	101523	Oil Seal	5
3	103142	Shaft Front Output	1
4	103134	Snap Ring	2
5	100158	Bearing	8
6	103136	Snap Ring	6
7	100160	Miter Gear	2
8	100045	Roll Pin, 3/16 x 1 1/4	2
9	101519	Spacer	1
10	100043	Woodruff Key #9	3
11	101506	Key #3	3
12	103143	Shaft Rear Output	1
13	101517	Gear 64T Drive	1
14	105082-2	End Cap	1
15	101511	Spacer	1
16	101637	Roll Pin, 3/32 x 1/2	2
17	101633	Gear Selector	1
18	101634	Shift Rod	1
19	101632	Selector Shaft	1
20	101528	Spring	1
21	101527	Ball	1
22	101530	Spacer	1
23	101541	Shift Knob	1
24	101631-3	Gear 40T	1
25	101631-2	Gear 51T	1

**Continued*

17-19 (Continued)

ITEM	PART NUMBER	DESCRIPTION	QTY
26	101631-1	Gear 60T	1
27	101516	Gear 32T	1
28	107039	Shaft Input	1
29	101505	Snap Ring	1
30	101548	Key Straight Cut	1
31	101510	Spacer	1
32	100047	Roll Pin, 3/16 x 1	1
33	101509-3	Gear 40T	1
34	101509-2	Gear 29T	1
35	101509-1	Gear 20T	1
36	100163	Plug	2
37	101525	Bolt, ¼ - 20 X 1	4
38	101524	Bolt, ¼ - 20 X 1 3/4	4
39	101939	Dowel Pin	2
40	105082-1	End Cap	1
41	108987	Pressure Relief Valve	1
42	101615	Shim .005	AS NEEDED
43	100163	Plug, Drain/Check/Fill	2
44	101598	Shim (1x1.5) .010	1

17-20 MITER BOX

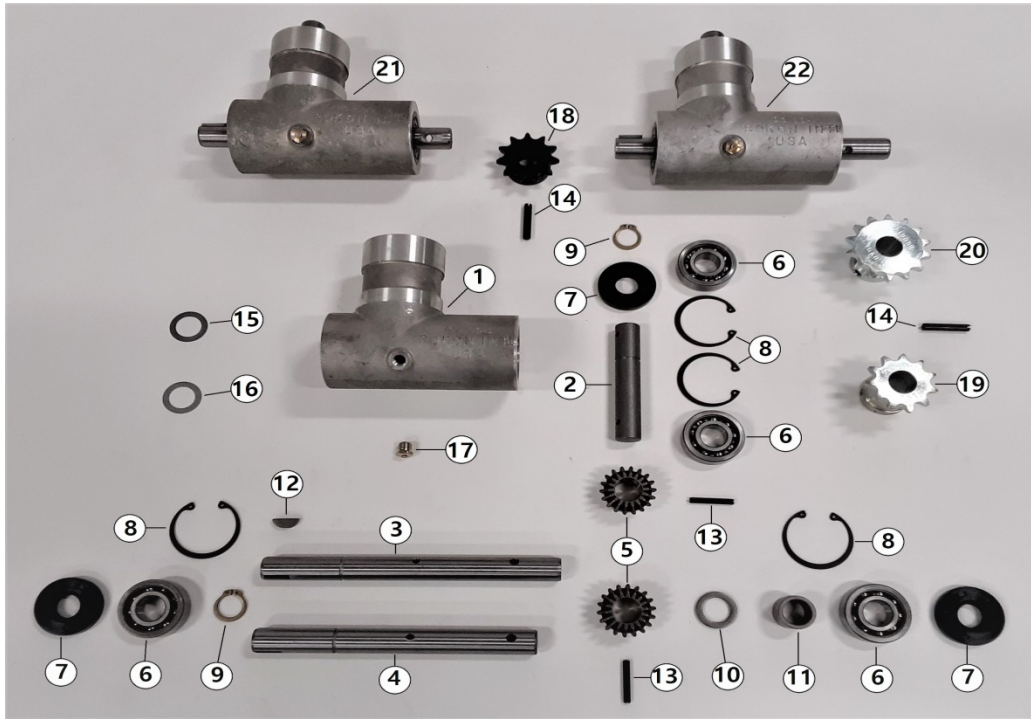

ITEM	PART NUMBER	DESCRIPTION	QTY
1	103130	Miter Box Case	1
2	108053	Input Shaft	1
3	110071	Output Shaft (Trail-Breaker & Ranger)	0-1
4	103132	Output Shaft (Scout)	0-1
5	100160	Miter Gear	2
6	100158	Bearing	4
7	101523	Oil Seal	3
8	103136	Snap Ring, Case ID	4
9	101505	Snap Ring, Shaft OD	2
10	100853	Spacer	1
11	100108	Spacer	1
12	100043	Woodruff Key #9	1
13	100045	Roll Pin, 3/16 x 1 1/4	2
14	100270	Roll Pin, 1/4 x 1 3/8	1
15	101615	Shim, 3/4 ID x .005	AS NEEDED
16	101616	Shim, 3/4 ID x .010	AS NEEDED
17	108987	Pressure Vent/Fill Plug	1
18	100040	Sprocket, 11T (Scout)	0-1
19	108331	Sprocket, 11T Extended (Trail-Breaker)	0-1
20	110050	Sprocket, 14T Extended (Ranger)	0-1
21	103131	Miter Box Assembly (Standard Fork)	0-1
22	103135	Miter Box Assembly (Autograb)	0-1

17-21 DRIVELINE

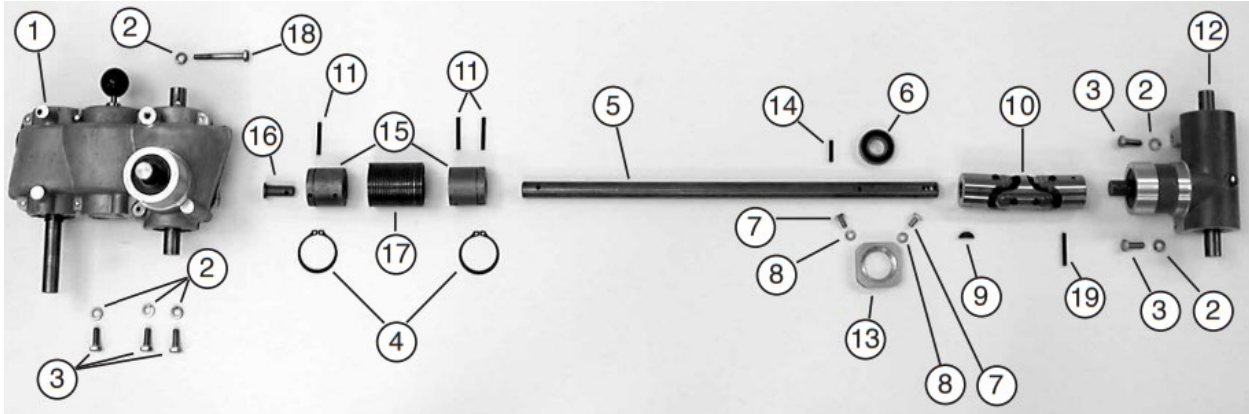

ITEM	PART NUMBER	DESCRIPTION	QTY
1	103140	Transmission Assembly	1
2	100039	Lock Washer, 5/16	6
3	100038	Bolt, 5/16 – 18 x 7/8	5
4	100307	Snap Ring	2
5	108079	Drive Shaft	1
6	100314	Drive Line Bearing	1
7	100167	Bolt, 1/4-28 x 1/2	2
8	100281	Lock Washer, 1/4	2
9	100043	Woodruff Key #9	1
10	108054	Universal Joint	1
11	100046	Roll Pin, 3/16 x 1 1/2	3
12	103131	Miter Box Assembly (Scout Model Shown)	1
13	100312	Bearing Retainer Drive Line Support	1
14	100047	Roll Pin, 3/16 x 1	1
15	101655	Drive Line Boss	2
16	101656	Retaining Pin	1
17	100002	Overrunning Clutch Spring	1
18	101529	Bolt, 5/16-18 x 2 1/4	1
19	100045	Roll Pin, 3/16 x 1 1/4	1

17-22 WHEEL (ALUMINUM DRUM)

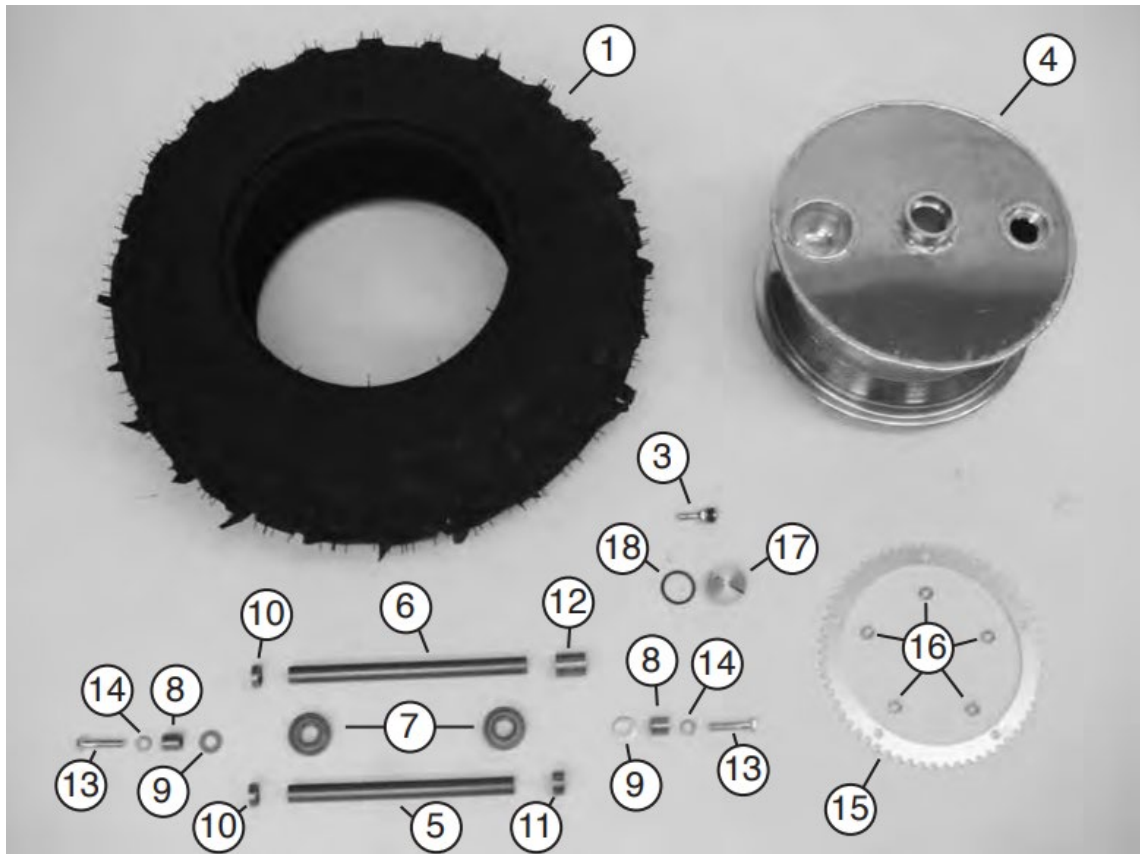

ITEM	PART NUMBER	DESCRIPTION	QTY
1	100840	Tire, 8 x 12 Maxxis 2.0	2
2	100846	Tire, Grim Reaper Radial (Not Shown)	2
3	100542	Valve Stem 12" Drum	2
4	108156A	Aluminum Wheel 12"	2
5	100405	Axle, Scout front + All Rears	2-1
6	108329	Axle, Front Suspension (Trail-Breaker + Ranger)	1
7	100772	Bearing	4
8	100522	Axle Spacer	4
9	100208	Washer, Flat	4
10	100756	Spacer Dead Side	2
11	100758	Spacer Sprocket Side	2
12	108330	Spacer, Autograb Sprocket Side	1
13	101181	Bolt, 3/8-24 x 1 3/4	4
14	100288	Lock washer, 3/8	4
15	108112	Sprocket 60T	2
16	100036	Nut, 3/8 - 24 Jam	10
17	100523	Plug	2
18	100516	O Ring	2

17-23 WHEEL (STEEL SPOKE)

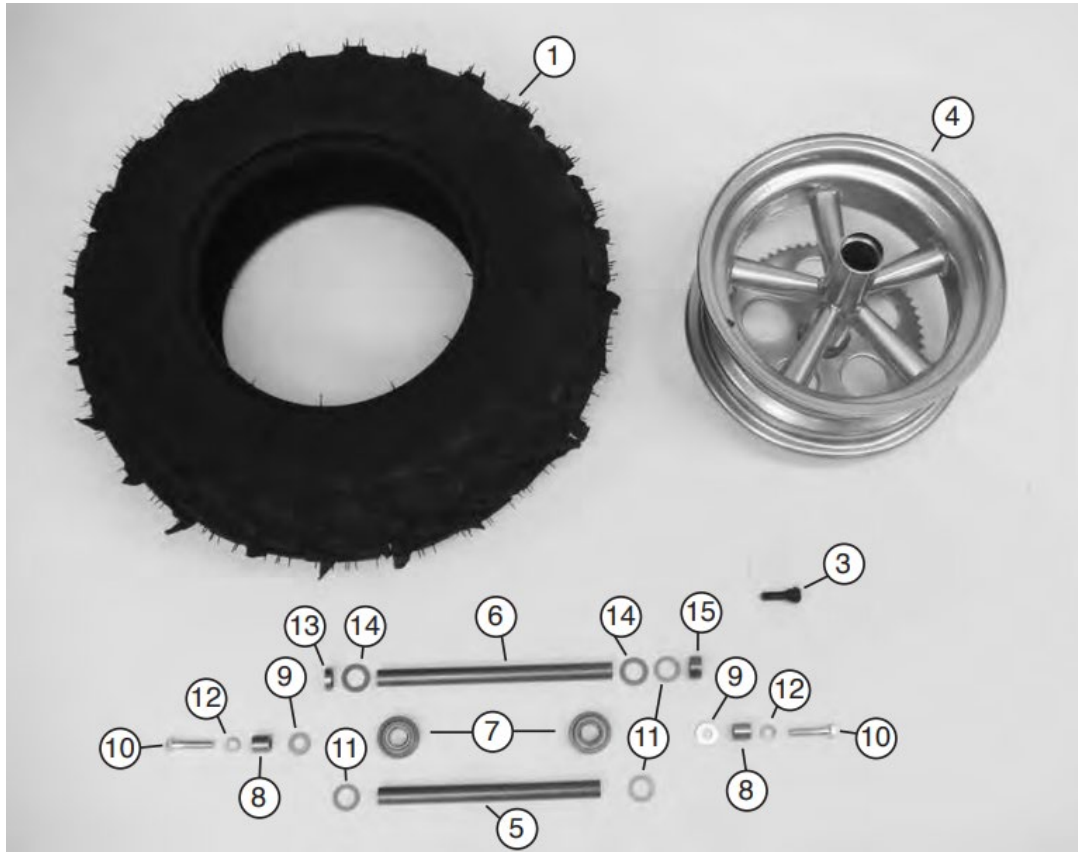

ITEM	PART NUMBER	DESCRIPTION	QTY
1	100836	Tire 8 x 12 Titan 489 XT	2
2	100846	Tire, Grim Reaper Radial (Not Shown)	2
3	100541	Valve Stem 12" Steel Wheel	2
4	100116	Wheel 12" Steel	2
5	100405	Axle, Scout front + All Rears	2-1
6	108329	Axle, Front Suspension (Trail-Breaker + Ranger)	1
7	100772	Bearing	2
8	100522	Axle Spacer	2
9	100208	Washer, Flat	2
10	101181	Bolt, 3/8-24 x 1 3/4	2
11	100853	Shim, 3/4	2
12	100288	Lock washer, 3/8	2
13	100756	Spacer, Dead Side	1
14	300090C	Washer, 3/4	2
15	100758	Spacer, Sprocket Side	1

17-24 TOW BARS (OPTIONAL)

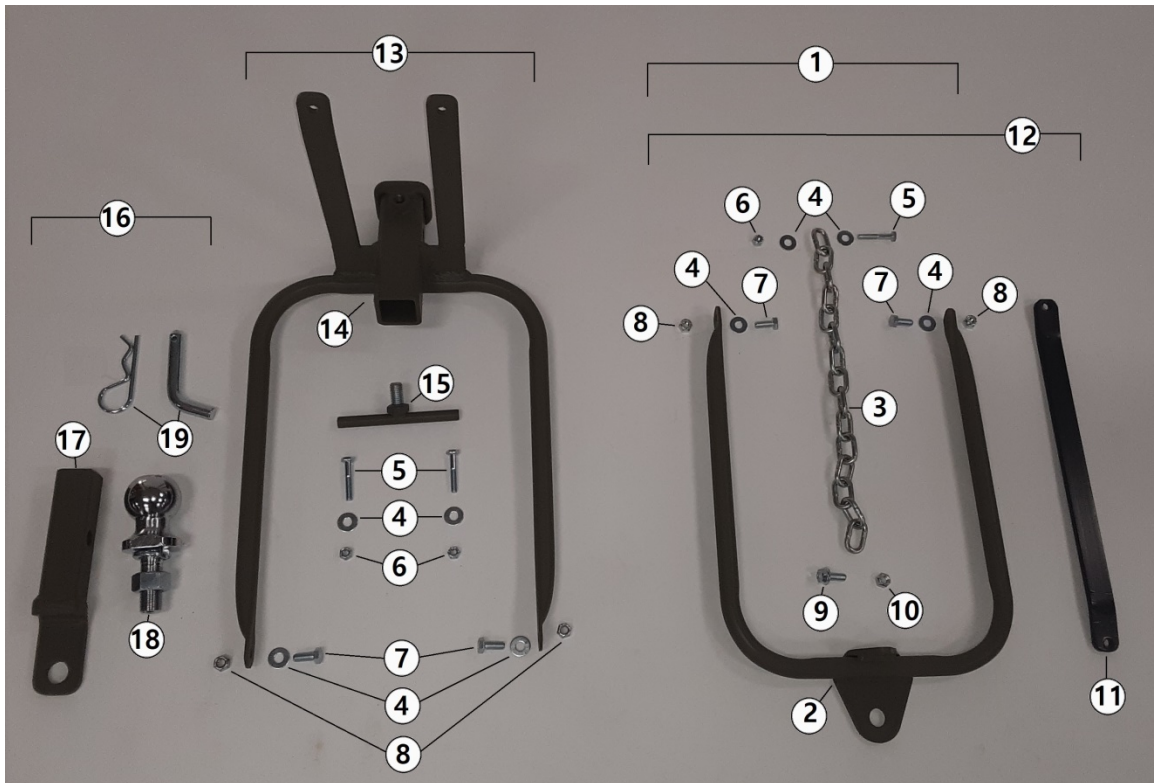

ITEM	PART NUMBER	DESCRIPTION	QTY
1	100893	Tow Bar Kit Soft (Includes 2-10)	
2	100349	Tow Bar	1
3	100007	Chain	1
4	100255	Washer, Flat	4
5	100170	Bolt, ¼ - 28 x 1 ½	1-2
6	100169	Lock Nut, ¼ - 28	1-2
7	100848	Bolt, 5/16 - 24 x ¾	2
8	100551	Lock Nut, 5/16 - 24	2
9	108943	Bolt, M8 x 1.25 -3/4	1
10	108966	Lock Nut, M8 x 1.25	1
11	103181	Rigid Tow Bar	1
12	100895	Tow Bar Kit Hard (Includes 2-11)	
13	100896	Receiver Tow Bar Kit (Includes 4,5,6,7,8,14,15)	
14	100891	Receiver Tow Bar (1 ¼ Receiver Tube)	1
15	100890	Anti-Sway Tensioner Bolt	1
16	100897	Ball Insert Kit for 100896 (Includes 17,18,19)	
17	105023	1 ¼ Ball Mount Insert	1
18	105029C	Trailer Ball	1
19	105025	Pin + Clip, Insert Retainer	1

17-25 REAR CARGO RACK (OPTIONAL)

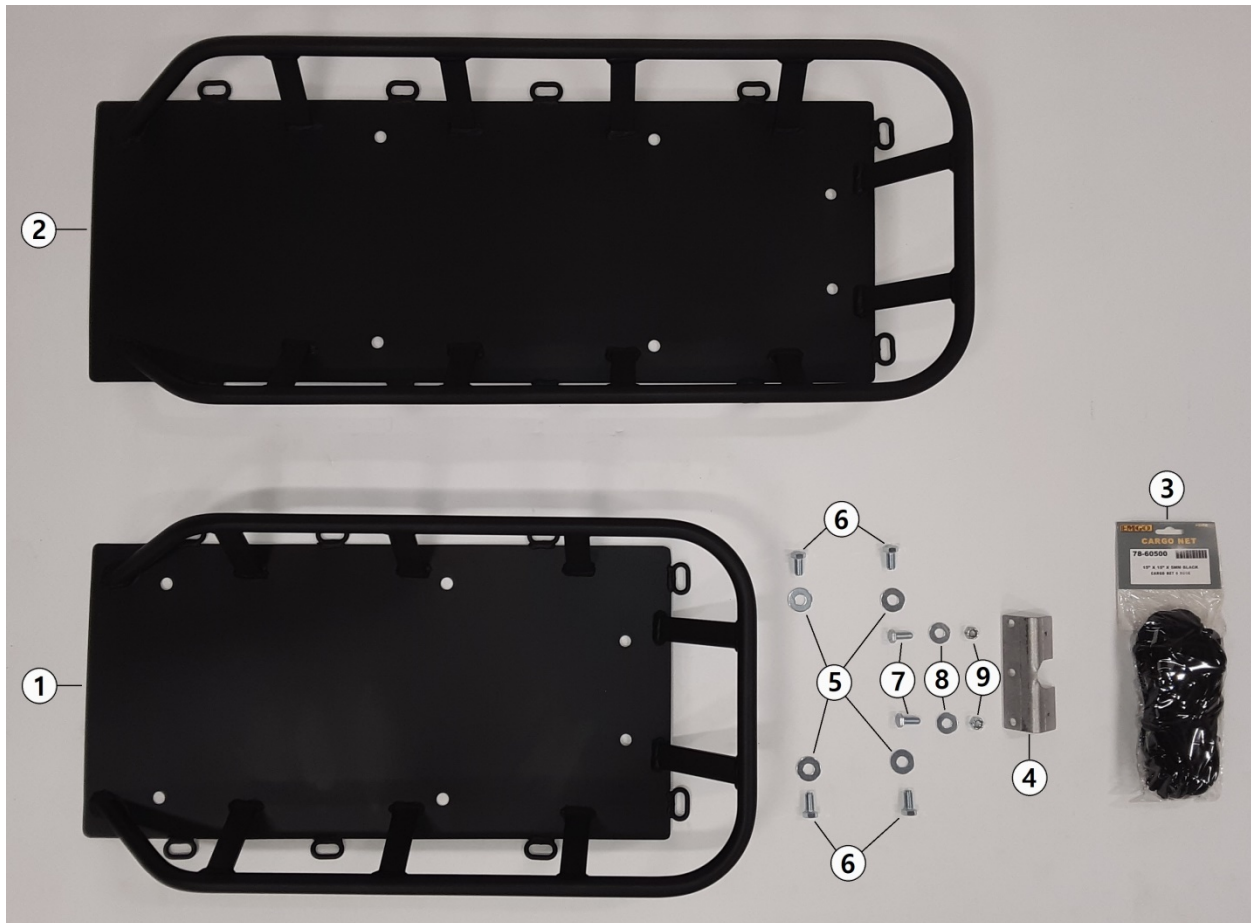

ITEM	PART NUMBER	DESCRIPTION	QTY
1	109018	Rear Cargo Rack	1
2	109020	*Extended Rear Cargo Rack (Mototractor)	1
3	108948	Cargo Netting	1
4	101136	Tail Light Bracket, Cargo Rack	1
5	100208	Washer, Flat	4
6	101572	Bolt, 3/8 – 24	4
7	100848	Bolt, 5/16 – 24 x 3/4	2
8	100202	Washer, Flat	2
9	100551	Lock Nut, 5/16 – 24	2

*Extended Rear Cargo Rack can only be used in conjunction with the Retro Seat Assembly (See section 17-14)

17-26 SIDECAR (OPTIONAL)

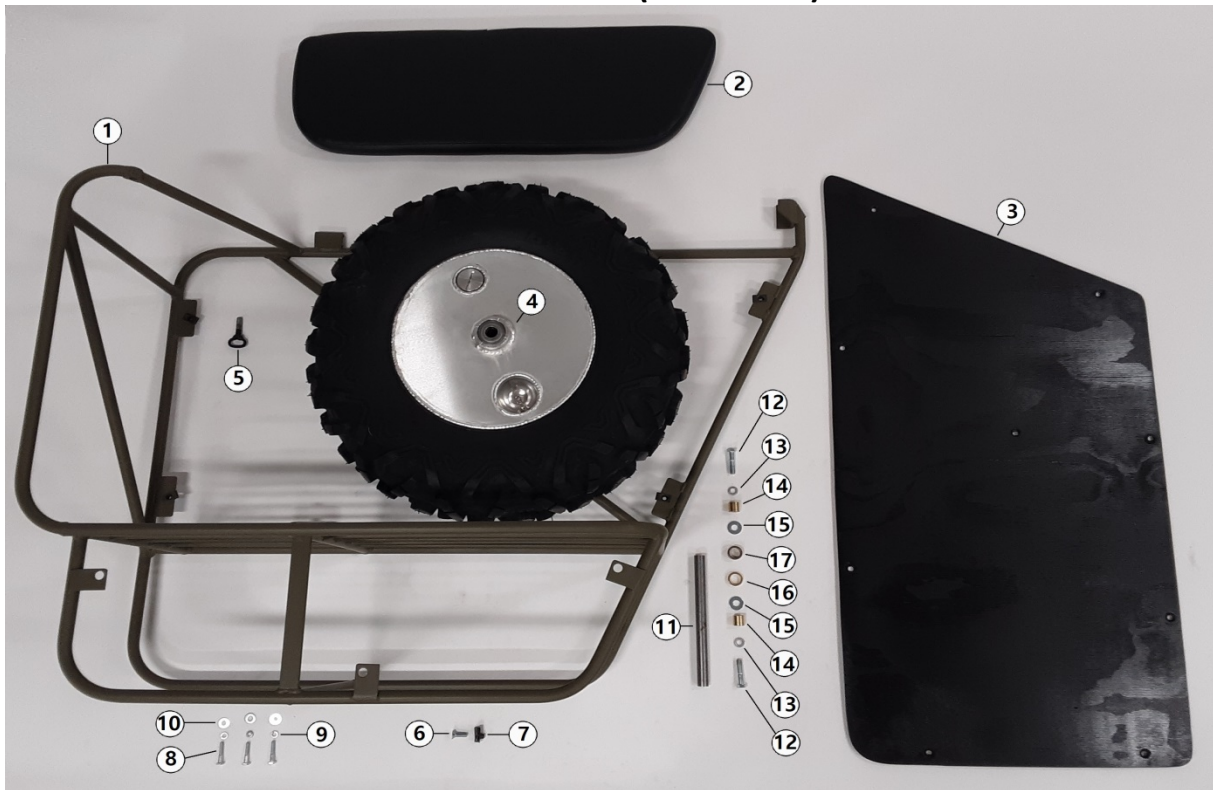

ITEM	PART NUMBER	DESCRIPTION	QTY
1	108156F	Sidecar Frame	1
2	100454	Sidecar Seat	1
3	104168	Decking, Sidecar	1
4	108157	*Drum Wheel, Sidecar (No Sprocket)	1
5	104167	Thumb Bolt, 3/8 – 24 x 1 3/4	1
6	FHA05C016Z	Deck Retaining Bolt,	9
7	101630	Receptacle Nut, Deck	9
8	105037	Bolt, 1/4 - 20 x 1 3/8	3
9	100281	Lock Washer, 1/4	3
10	100255	Washer, Flat	3
11	100405	Axle	1
12	101181	Bolt, 3/8-24 x 1 3/4	2
13	100288	Lock washer, 3/8	2
14	100522	Axle Spacer	2
15	100208	Washer, Flat	2
16	100756	Spacer, Fill Side	2
17	100758	Spacer, Flat Side	2
ALL ABOVE	104166	Sidecar Assembly	
NS	100454MB	Sidecar Seat, Camouflage	
NS	100116S	*Spoke Wheel, Sidecar (No Sprocket)	1

*See sections 17-22 & 17-23 for wheel assembly details, sidecar wheel has no sprocket.

18. WIRING DIAGRAMS

Off – Highway, SCOUT and TRAIL-BREAKER

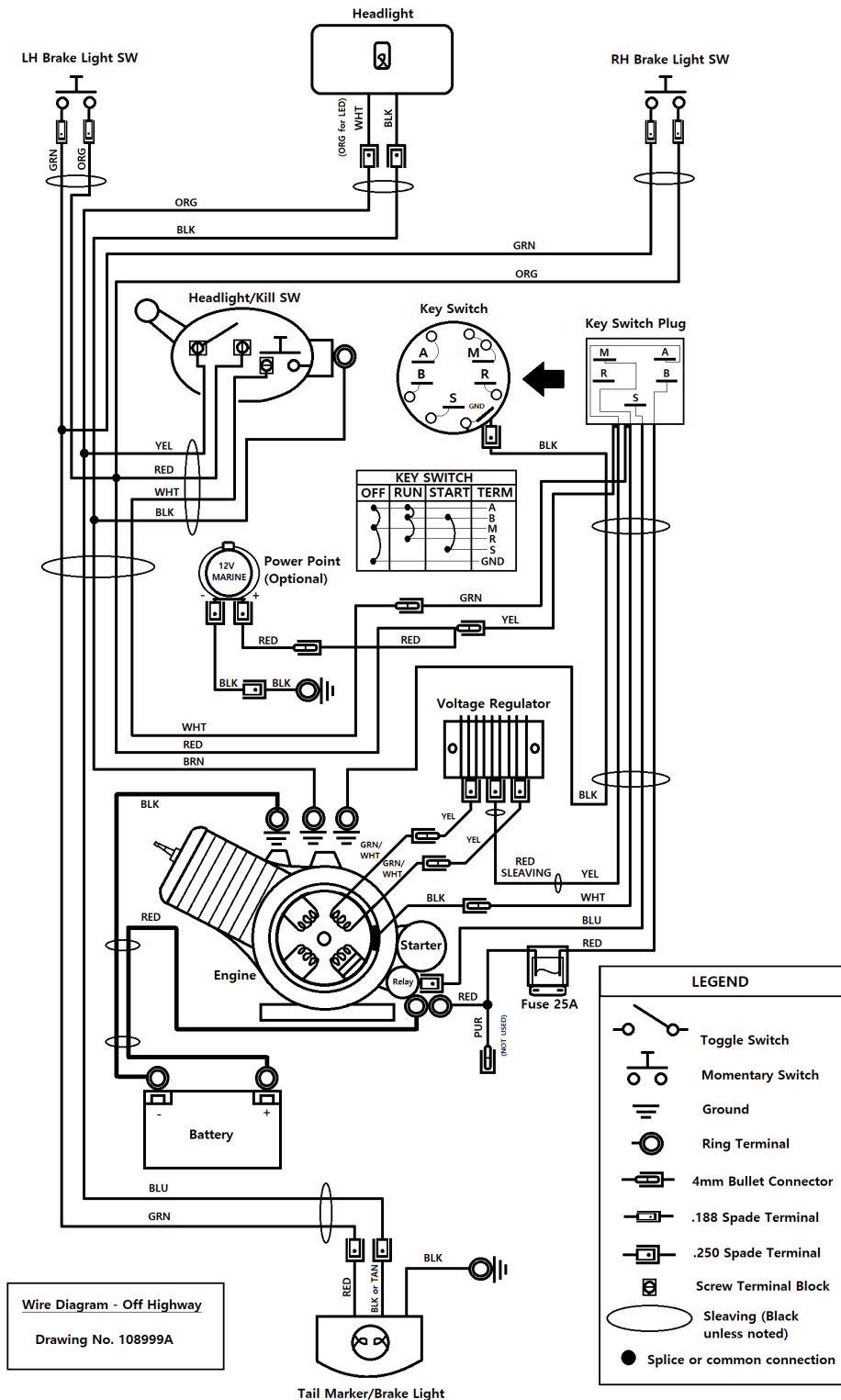

Street Legal RANGER PART 1

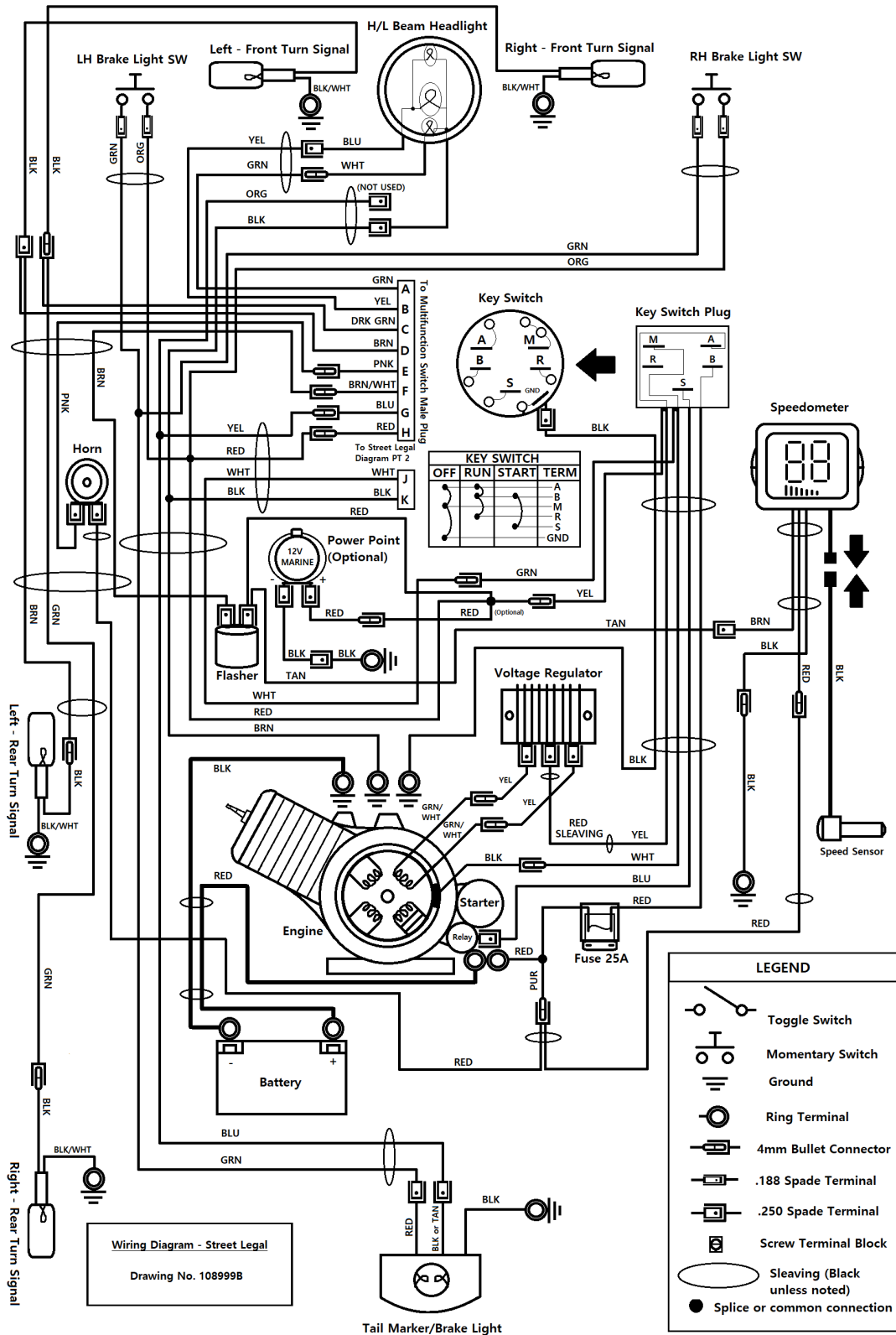

WIRING DIAGRAMS (Continued)

Street Legal RANGER PART 2

WIRE COLOR/FUNCTION CHART			
COLOR	FUNCTION	NUM	LTR
YEL	HIGH BEAM	1	B
BLK	HORN GROUND	2	I
BRN	LEFT TURN SIGNAL	3	D
GRN	LOW BEAM	4	A
BRN/WHT	TURN SIG MAIN WIRE	5	F
RED	HEADLIGHT MAIN WIRE	6	H
BLU	PARKING LIGHT	7	G
PNK	HORN MAIN WIRE	8	E
DRK GRN	RIGHT TURN SIGNAL	9	C
BLU/WHT	KILL SWITCH MAIN		J
BLK/WHT	KILL SWITCH GROUND		K

KS12-0050

Multifunction Switch

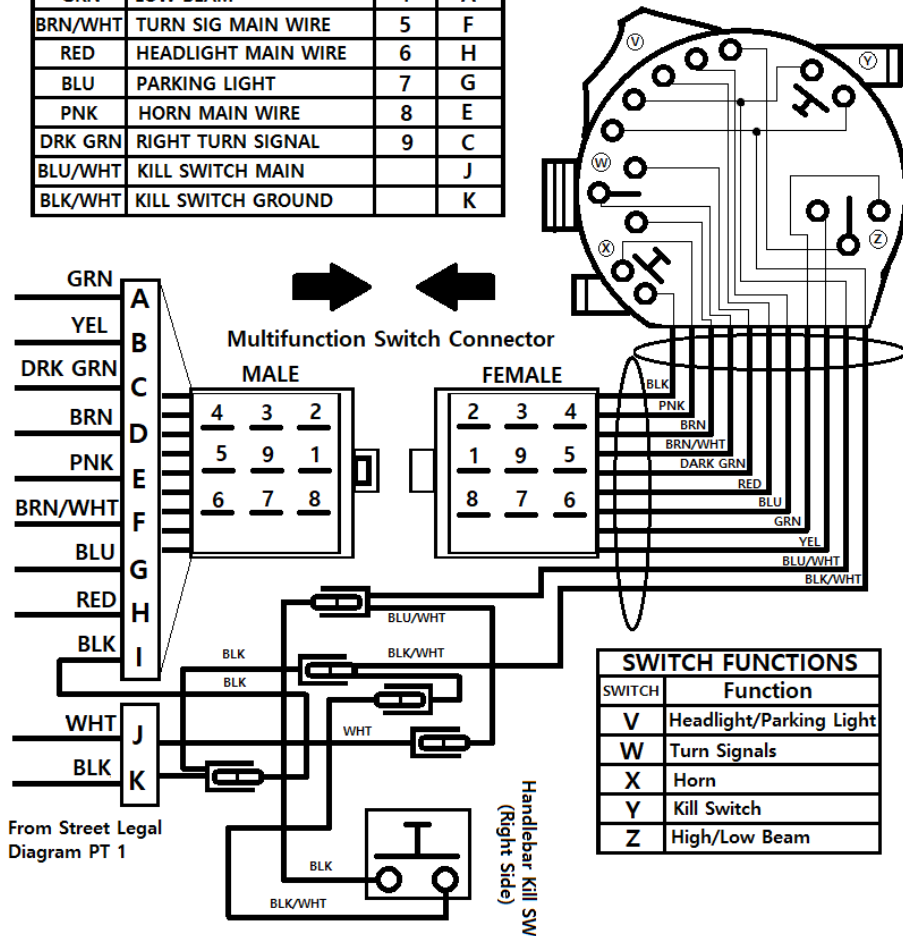

19. WARRANTY INFORMATION

ROKON WARRANTY SYSTEM

ROKON International Inc. warranties to the original purchaser, new ROKON Utility Vehicles to be free of defects that are the result of faulty workmanship or material, for a period of one year from the date of purchase for new year model ROKONs only. In the case of competition machines, no warranty is expressed or implied. The entire risk to the quality and performance of competition machines is with the buyer.

Warranty will be honored through any authorized ROKON dealer or the factory. To validate warranty, Purchaser must: Complete and return Warranty Registration Card to ROKON International Inc. within ten (10) days of purchase.

Notify ROKON of any and all defects made within ten (10) days of malfunction and make machine immediately available for inspection at a place to be determined by ROKON.

Have warranty service performed by an authorized ROKON agent as directed by ROKON.

Warranty will not cover:

- Parts replaced as a result of normal wear. (ie. spark plugs, tires, tubes, and so forth)
- Parts subject to misuse, neglect, or modification.
- Parts damaged as a result of accident or collision.
- Machines used for rental and/or lease.
- Machines used in competitive events.
- Machine abuse.

ROKON International Inc.'s liability shall be limited to that set forth herein, and no other claims for consequential damage or injury to person or property will be admissible. All other conditions and warranties, statutory or otherwise, and whether expressed or implied, including, but not limited to, implied warranties of merchantability or fitness for a particular use, are hereby excluded. This implied warranty exclusion is not applicable in states having laws to the contrary.



20. EMISSIONS CONTROL SYSTEM INFORMATION

Rokon International Inc. – Emission Control System Warranty Statement (Off-Highway)

YOUR WARRANTY RIGHTS AND OBLIGATIONS

The U.S. Environmental Protection Agency and **Rokon International Inc.** (hereinafter “**Rokon**”), are pleased to explain the emission control system warranty on your Off-Road Motorcycle. New off-road motor vehicles must be designed, built and equipped to meet U.S. EPA Federal standards. Rokon must warrant the emission control system on your vehicle for 5,000 km, or at least 30 months, whichever comes first, provided that there has been no abuse, neglect or improper maintenance of your vehicle. This off-road motorcycle was designed to meet the emission standards for 10,000 km, or five years, whichever comes first.

Your emission control system may include parts such as the carburetor or fuel injection system, the ignition system, catalytic converter and engine computer, if it is equipped. Also included may be hoses, belts, connectors and other emission-related assemblies.

Where a warrantable condition exists, Rokon will repair your vehicle at no cost to you, including diagnosis, parts and labor.

If an emission-related part on your vehicle is defective, the part will be repaired or replaced by Rokon. This is your emission control system DEFECTS WARRANTY.

NOTICE! Use of any Rokon brand vehicle in any type of competitive event completely and absolutely voids this and all other warranties offered by Rokon.

OWNER'S WARRANTY RESPONSIBILITIES

As the vehicle owner, you are responsible for the performance of the required maintenance listed in your owner's manual. Rokon recommends that you retain all receipts covering maintenance on your vehicle, but Rokon cannot deny warranty solely for the lack of receipts or for your failure to ensure the performance of all scheduled maintenance.

You are responsible for presenting your vehicle to the Rokon dealer as soon as a problem exists. The warranty repairs should be completed in a reasonable amount of time, not to exceed 30 days.

As the vehicle owner, you should be aware that Rokon may deny your warranty coverage if your vehicle or a part has failed due to abuse, neglect, improper maintenance or unapproved modifications.

If you use your vehicle in any type of competitive event, this warranty is immediately and completely void.

If you have any questions regarding your warranty rights and responsibilities, you should contact Rokon International Inc., 50 Railroad Avenue, Rochester, NH 03839, Phone: 603-335-3200, or the U.S. Environmental Protection Agency at 2000 Traverwood Drive, Ann Arbor, MI 48105.

The logo for Rokon International Inc. features the word "ROKON" in a bold, red, sans-serif font with a black outline and a slight 3D effect. The letters are closely spaced and the overall design is modern and industrial.

Rokon International Inc. - Limited Warranty on Emission Control System (Off-Highway)

YOUR WARRANTY RIGHTS AND OBLIGATIONS

Rokon warrants that each new Rokon brand off-road motorcycle:

- A. is designed, built and equipped so as to conform at the time of initial retail purchase with all applicable regulations of the United States Environmental Protection Agency, and;
- B. is free from defects in material and workmanship which cause such vehicle to fail to conform to applicable regulations of the United States Environmental Protection Agency for the periods specified above.

I. **Coverage.** Warranty defects shall be remedied during customary business hours at any authorized Rokon dealer located within the United States of America in compliance with the Clean Air Act and applicable regulations of the United States Environmental Protection Agency. Any part or parts replaced under this warranty shall become the property of Rokon.

II. **Limitations** This Emission Control System Warranty shall not cover any of the following:

A. Repair or replacement as a result of

- (1) Accident,
- (2) Misuse,
- (3) Repairs improperly performed or replacements improperly installed,
- (4) Use of replacement parts or accessories not conforming to specifications set forth by Rokon, which adversely affect performance and/or
- (5) Use in competitive racing or related events.

B. Inspections, replacement of parts and other services and adjustments required for required maintenance.

C. Any vehicle equipped with an odometer or hour meter on which the odometer mileage or hour meter reading has been changed so that actual mileage cannot be readily determined.

III. **Limited Liability**

A. The liability of Rokon under this Emission Control System Warranty is limited solely to the remedying of defects in material or workmanship by an authorized Rokon dealer at its place of business during customary business hours. This warranty does not cover inconvenience or loss of use of the vehicle or transportation of the vehicle to or from the Rokon dealer. Rokon shall not be liable for any other expenses, loss or damage, whether direct, incidental, consequential or exemplary arising in connection with the sale or use of or inability to use the Rokon brand vehicle for any purpose. Some states do not allow the exclusion or limitation of any incidental or consequential damages, so the above limitations may not apply to you.

The ROKON logo is displayed in a bold, red, sans-serif font with a black outline and a slight shadow effect, centered at the bottom of the page.

Rokon International Inc. - Limited Warranty on Emission Control System (Off-Highway)

B. No express emission control system warranty is given by Rokon, except as specifically set forth herein. Any emission control system warranty implied by law, including any warranty of merchantability or fitness for a particular purpose, is limited to the express emission control system warranty terms stated in this warranty. The foregoing statements of warranty are exclusive and in lieu of all other remedies. Some states do not allow limitations on how long an implied warranty lasts, so the above limitations may not apply to you.

C. No dealer is authorized to modify this Limited Emission Control System Warranty issued by Rokon.

IV. LEGAL RIGHTS. This warranty gives you specific legal rights, and you may also have other rights which vary from state to state.

V. This warranty is in addition to the Rokon limited vehicle warranty.

VI. ADDITIONAL INFORMATION. Any replacement part that is equivalent in performance and durability may be used in the performance of any maintenance or repairs. However, Rokon are not liable for these parts. The owner is responsible for the performance of all required maintenance. Such maintenance may be performed at a service establishment or by any individual. The warranty period begins on the date the OFMC is delivered to an ultimate purchaser.

If you have any questions regarding your warranty rights and responsibilities, you should contact Rokon International Inc., at the address and phone number listed below, or the U.S. Environmental Protection Agency at 2000 Traverwood Drive, Ann Arbor, MI 48105.

Rokon International Inc.
50 Railroad Avenue
Rochester, NH 03839
Phone: 603-335-3200
Fax: 603-335-4400
Toll Free: 800-593-2369

The logo for ROKON, featuring the word "ROKON" in a bold, red, sans-serif font with a black outline and a slight shadow effect.

Rokon International Inc. - Emission Control System Warranty Statement (On-Highway)

YOUR WARRANTY RIGHTS AND OBLIGATIONS

The U.S. Environmental Protection Agency and Rokon International Inc., (hereinafter Rokon), are pleased to explain the emission control system warranty on your 2021 motorcycle. New motorcycles must be designed, built, and equipped to meet U.S. EPA standards. Rokon must warrant the emission control system on your motorcycle for the periods of time listed below provided there has been no abuse, neglect or improper maintenance of your motorcycle. Your emission control system may include parts such as the carburetor or fuel-injection system, the ignition system, catalytic converter and engine computer. Also included may be hoses, belts, connectors and other emission-related assemblies. Where a warrantable condition exists, Rokon will repair your motorcycle at no cost to you, including diagnosis, parts and labor.

MANUFACTURER'S WARRANTY COVERAGE

- Class II motorcycles (170 to 279 cc): for a period of use of five (5) years or 18,000 kilometers (11,185) miles, whichever first occurs.

If an emission-related part on your motorcycle is defective, the part will be repaired or replaced by Rokon. This is your emission control system DEFECTS WARRANTY.

OWNER'S WARRANTY RESPONSIBILITIES

- As the motorcycle owner, you are responsible for the performance of the required maintenance listed in your Owner's manual. Rokon recommends that you retain all receipts covering maintenance on your motorcycle, but Rokon cannot deny warranty solely for the lack of receipts or for your failure to ensure the performance of all scheduled maintenance.
- You are responsible for presenting your motorcycle to a Rokon dealer as soon as a problem exists. The warranty repairs should be completed in a reasonable amount of time, not to exceed 30 days.
- As the motorcycle owner, you should be aware that Rokon may deny your warranty coverage if your motorcycle or a part has failed due to abuse, neglect, improper maintenance or unapproved modifications.

If you have any questions regarding your warranty rights and responsibilities, you should contact Rokon International Inc. at 50 Railroad Avenue, Rochester, NH 03839 (Phone: 603-335-3200 or 800-593-2369), or the U.S. Environmental Protection Agency, 2000 Traverwood Drive, Ann Arbor, MI 48105.

The logo for Rokon International Inc. features the word "ROKON" in a bold, stylized font. The letters are red with a black outline and a slight 3D effect. A registered trademark symbol (®) is located at the bottom right of the letter "N".

Rokon International Inc. - Limited Warranty on Emission Control System (On-Highway)

Rokon International, Inc. (hereinafter Rokon) warrants that each new 2021 Rokon motorcycle, which includes as standard equipment a headlight, taillight and stoplight, and is street legal:

- A. is designed, built and equipped so as to conform at the time of initial retail purchase with all applicable regulations of the United States Environmental Protection Agency.
 - B. is free from defects in material and workmanship which cause such motorcycle to fail to conform with applicable regulations of the United States Environmental Protection Agency for a period of use of 18,000 kilometers (11,185 miles), if the motorcycle's engine displacement is equal to or greater than 170 cubic centimeters but less than 280 cubic centimeters or 5 (five) years from the date of initial retail delivery, whichever first occurs.
 - I. **COVERAGE.** Warranty defects shall be remedied during customary business hours at any authorized Rokon motorcycle dealer located within the United States of America in compliance with the Clean Air Act and applicable regulations of the United States Environmental Protection Agency. Any part or parts replaced under this warranty shall become the property of Rokon.
 - II. **LIMITATIONS.** This Emission Control System warranty shall not cover any of the following:
 - A. Repair or replacement required as a result of
 - (1) Accident,
 - (2) Misuse,
 - (3) Repairs improperly performed or replacements improperly installed,
 - (4) Use of replacement parts or accessories not conforming to Rokon's specifications which adversely affect performance and/or
 - (5) Use in competitive racing or related events.
 - B. Inspections, replacement of parts and other services and adjustments required for required maintenance.
 - C. Any motorcycle on which the odometer mileage has been changed so that actual mileage cannot be readily determined.
- III. **LIMITED LIABILITY.**
 - A. The liability of Rokon under this Emission Control System Warranty is limited solely to the remedying of defects in material workmanship by an authorized Rokon motorcycle dealer at its place of business during customary business hours. This warranty does not cover inconvenience or loss of use of the motorcycle or transportation of the motorcycle to or from the Rokon dealer. ROKON SHALL NOT BE LIABLE FOR ANY OTHER EXPENSES, LOSS OR DAMAGE, WHETHER DIRECT, INCIDENTAL, CONSEQUENTIAL OR EXEMPLARY ARISING IN CONNECTION WITH THE SALE OR USE OF OR INABILITY TO USE THE ROKON VEHICLE FOR ANY PURPOSE. SOME STATES DO NOT ALLOW THE EXCLUSION OR LIMITATION OF ANY INCIDENTAL OR CONSEQUENTIAL DAMAGES, SO THE ABOVE LIMITATIONS MAY NOT APPLY TO YOU.
 - B. NO EXPRESS EMISSION CONTROL SYSTEM WARRANTY IS GIVEN BY ROKON EXCEPT AS SPECIFICALLY SET FORTH HEREIN. ANY EMISSION CONTROL SYSTEM WARRANTY IMPLIED BY LAW, INCLUDING ANY WARRANTY OF THE MERCHANTABILITY OR FITNESS FOR A PARTICULAR PURPOSE, IS LIMITED TO THE

EXPRESS EMISSION CONTROL SYSTEM WARRANTY TERMS STATED IN THIS WARRANTY. THE FOREGOING STATEMENTS OF WARRANTY ARE EXCLUSIVE AND IN LIEU OF ALL OTHER REMEDIES. SOME STATES DO NOT ALLOW LIMITATIONS ON HOW LONG AN IMPLIED WARRANTY LASTS SO THE ABOVE LIMITATIONS MAY NOT APPLY TO YOU.

- C. No dealer is authorized to modify this Limited Emission Control System Warranty.
- IV. **LEGAL RIGHTS.** THIS WARRANTY GIVES YOU SPECIFIC LEGAL RIGHTS, AND YOU MAY ALSO HAVE OTHER RIGHTS WHICH VARY FROM STATE TO STATE.
- V. **THIS WARRANTY IS IN ADDITION TO THE ROKON LIMITED MOTORCYCLE WARRANTY.**
- VI. **ADDITIONAL INFORMATION.** Any replacement part that is equivalent in performance and durability may be used in the performance of any maintenance or repairs. However, Rokon is not liable for these parts. The owner is responsible for the performance of all required maintenance. Such maintenance may be performed at a service establishment or by any individual. The warranty period begins on the date the motorcycle is delivered to an ultimate purchaser.

ROKON INTERNATIONAL INC.
50 Railroad Avenue
Rochester, NH 03839
Phone: 603-335-3200
Fax: 603-335-4400
Toll Free: 800-593-2369



ROKON

C.A.R.B. (California Air Resource Board) Emission System Warranty Statement (Motorcycle)

On-Highway, California RANGER Models

DISTRIBUTOR'S LIMITED WARRANTIES EMISSION CONTROL SYSTEMS

The California Air Resources Board and ROKON International, Inc. are pleased to explain the emission control system warranty on your 2021 motorcycle. In California, new motorcycles must be designed, built and equipped to meet the State's stringent anti-smog standards. ROKON International, Inc. must warrant the emission control system on your motorcycle for the period of time listed below provided there has been no abuse, neglect, or improper maintenance of your motorcycle.

Your emission control system may include parts such as the carburetor or fuel injection system, the ignition system, catalytic converter, and engine computer. Also included may be hoses, belts, connectors, and other emission related assemblies.

Your ROKON International, Inc. motorcycle complies with U.S. EPA and California ARB emissions regulations. ROKON International, Inc. provides the same warranty coverage to all motorcycle owners, regardless of where the motorcycle is registered.

Your Warranty Rights and obligations: In the United States new motorcycles must be designed, built and equipped to meet stringent federal anti-smog standards. ROKON International, Inc. must warrant the emissions control system on your motorcycle for the periods of time listed below, provided there has been no abuse or neglect of your motorcycle. Your emissions control system may include parts such as the sensors, the ignition and the engine computer. Also included may be hoses, connectors and other emissions-related assemblies. Where a warrantable condition exists, ROKON International, Inc. will repair your motorcycle at no cost to you, including diagnosis, parts, and labor.

Manufacturer's Warranty Coverage: If any emissions-related part on your vehicle is defective, the part will be repaired or replaced by ROKON International, Inc. This is your emissions control system DEFECTS WARRANTY.

Owner's Warranty Responsibilities:

As the motorcycle owner, you are responsible for the performance of the required maintenance listed in your Owner's Manual. ROKON International, Inc. recommends that you retain all receipts covering maintenance on your motorcycle, but ROKON International, Inc. cannot deny warranty solely for the lack of receipts or for your failure to ensure the performance of all scheduled maintenance. You are responsible for presenting your motorcycle to ROKON International, Inc. dealer as soon as a problem exists. The warranty repairs should be completed in a reasonable amount of time, not to exceed, 30 days.

Emission system Warranty Statement (Motorcycle): As the motorcycle owner, you should also be aware that ROKON International, Inc. may deny you warranty coverage if your motorcycle or a part has failed due to abuse, neglect, or unapproved modifications. If you have any questions regarding your warranty rights and responsibilities or if an authorized ROKON International, Inc. dealer cannot repair your motorcycle or honor your claim within a reasonable period of time, contact ROKON International, Inc. @ (603)828-5375 for assistance. If you are not satisfied with the way in which a warranty claims resolved by ROKON International, Inc., you may write directly to:

Director of Field Operations U.S. Environmental Protection Agency Office of Transportation & Air Quality,
2000 Traverwood Dr. Ann Arbor, MI 48105

California Air Resource Board 9528 Telstar Ave El Monte, CA 91731-2990

Emissions Warranty Coverage:

ROKON International, Inc. warrants to the owner of any 2021 and subsequent model year motorcycle that the motorcycle is designed, built and equipped to conform at the time of sale with all applicable emission standards, and is free from defects in materials and workmanship which would cause it to fail to conform with applicable requirements during the specified time and mileage limits.

This warranty begins on the date the motorcycle is delivered to the first purchaser other than an authorized ROKON International, Inc. motorcycle dealer, or the date it is first used as a demonstrator, lease, or company motorcycle, whichever comes first and continues for the time and mileage listed below:

Time: 5 years
Mileage: 11,160 Miles (18,000 kilometers)

These warranties are given only to the owner of a 2021 and subsequent model year motorcycle distributed by ROKON International Inc.

Emission System warranty Statement (Motorcycle):

To qualify for coverage under the defects warranty you should operate and maintain your motorcycle according to the requirements of the Warranty Booklet, and the Maintenance Schedule in the Owner's Manual. This schedule is designed to keep your motorcycle emission control systems functioning properly by maintaining your motorcycle in peak operating condition. ROKON International, Inc. will not deny a warranty claim solely because of lack of maintenance records. However, failures caused by abuse will not be covered by this warranty.

ROKON International, Inc. recommends that only parts supplied by ROKON International, Inc. or equivalent parts be used to repair your motorcycle. Maintenance, replacement, or repair of emission control devices and systems may be done by any motorcycle repair establishment or individual. ROKON International, Inc. will only pay for warranty repairs performed at an authorized ROKON International, Inc. motorcycle repair facility (except in an emergency situation). An emergency situation exists when a ROKON International, Inc. dealership is not reasonably available; a warranted part is not available within 30 days, or when an authorized ROKON International, Inc. facility is unable to complete a repair within 30 days. In an emergency situation, the repair of emission control devices or system may be done by any motorcycle repair establishment or individual, or by the owner, using any replacement part. ROKON International, Inc. will reimburse you for those emergency repairs, including diagnosis, covered by the Emissions Warranties. Parts reimbursement is at the manufacturer's suggested retail price, and labor reimbursement is at a geographically-appropriate hourly labor rate for ROKON International, Inc. recommended time allowance. For reimbursement, present the replaced parts and a copy of the paid receipt to ROKON International, Inc.

The use of replacement parts not equivalent to the original parts may impair the effectiveness of your motorcycle's emissions control systems. If such a replacement part is used in the maintenance or repair of your motorcycle, and an authorized ROKON International, Inc. dealer determines it is defective or caused a failure of a warranted part, your claim for repair to bring your motorcycle into compliance with applicable standards may be denied. If the part in question is not related to the reason your motorcycle fails to meet the standards, your claim will not be denied.



21. TORQUE SPECS

NOTICE: Refer to **KOHLER ENGINE MANUAL** for engine fastener values

<u>Fastener Size</u>	<u>Torque Spec</u>	
<u>SAE</u>		
10-32	25 In-Lbs	2.8 N-M
1/4	84 In-Lbs	9.5 N-M
5/16	15 Ft-Lbs	20.3 N-M
3/8	30 Ft-Lbs	40.7 N-M
1/2	60 Ft-Lbs	81.3 N-M
3/4	200 Ft-Lbs	271.1 N-M
<u>METRIC</u>		
M5	25 In-Lbs	2.8 N-M
M6	84 In-Lbs	9.5 N-M
M8	15 Ft-Lbs	20.3 N-M
M10	30 Ft-Lbs	40.7 N-M

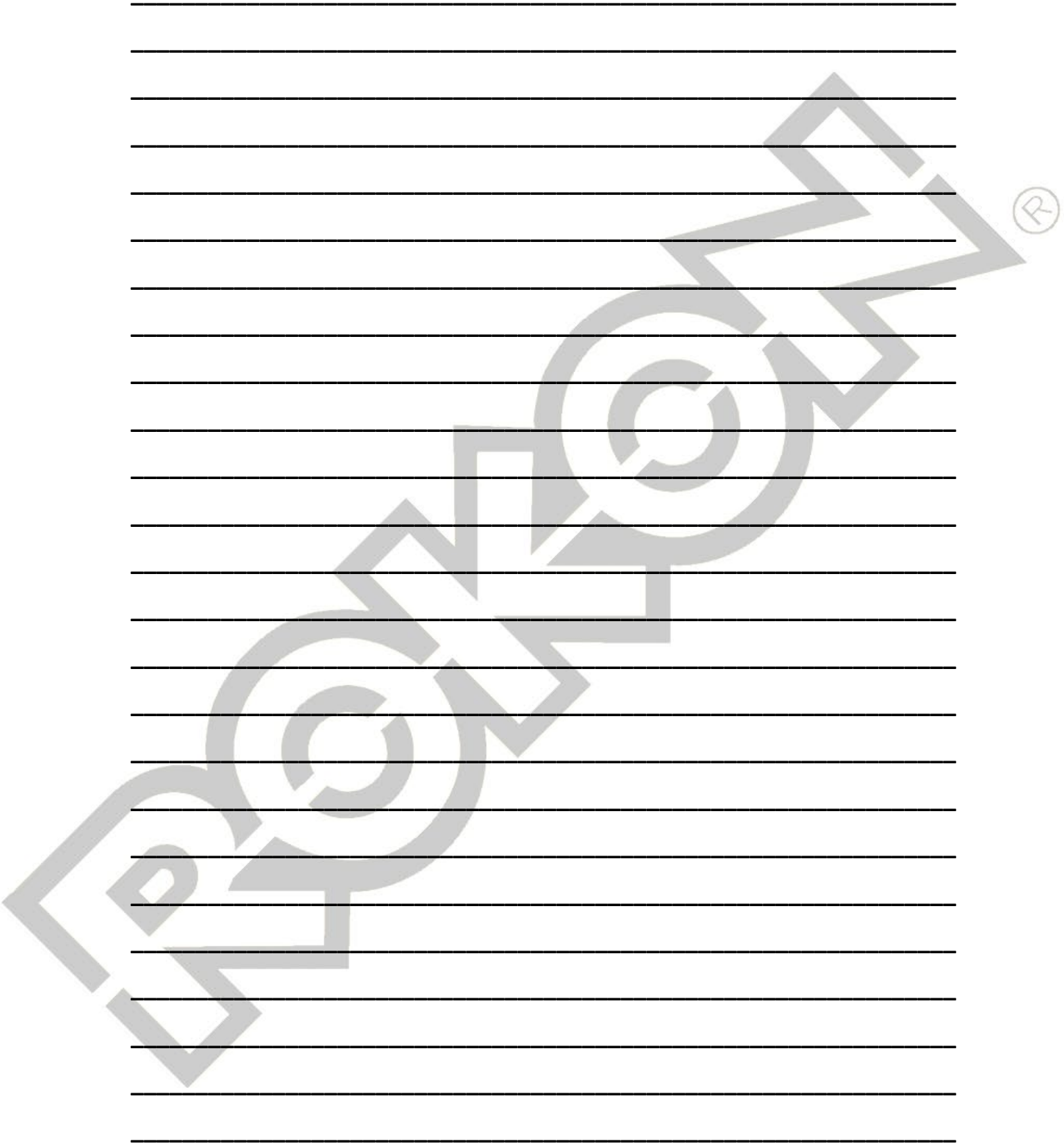

PROZOM®